

INCOMING LINES

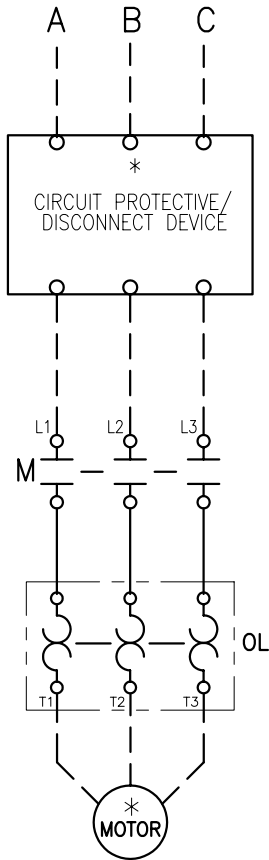

**CUSTOMER SUPPLIED
CONTROL VOLTAGE**

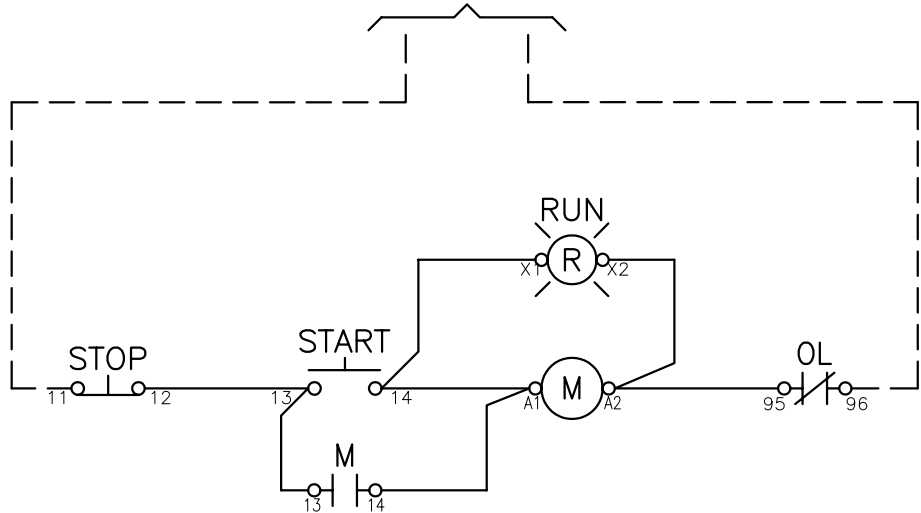

NOTES

1. COLOR OF CONTROL WIRE SHALL BE PER VOLTAGE ON CONTACTOR COILS:
RED-ALL AC VOLTAGES
WHITE MAY BE USED ON THE GROUNDED SIDE OF THE AC CIRCUIT IF SPECIFIED.
BLUE-ALL DC VOLTAGES
2. ALL DEVICES ARE SHOWN DE-ENERGIZED.
3. DO NOT USE SELECTOR SWITCHES WITH AUTO-RESET OVERLOAD RELAYS.

4. WIRE POINT TO POINT.

LEGEND	
CCT	CONTROL CIRCUIT TRANSFORMER
CHFUS	CCT PRIMARY FUSE
CXFUS	CCT SECONDARY FUSE
M	CONTACTOR
OL	OVERLOAD RELAY
o13	CONN POINT ON DEVICE WITH NUMBER
*	REMOTE DEVICE
∅	CONNECTION POINT AT TERMINAL BLOCK

CUST

REV. LET.	REVISIONS	DATE	REV OR APPD BY	THIS DRAWING IS THE PROPERTY OF ABB Inc. AND CONTAINS PROPRIETARY AND CONFIDENTIAL INFORMATION WHICH MUST NOT BE DUPLICATED, USED OR DISCLOSED OTHER THAN EXPRESSLY AUTHORIZED BY ABB Inc.		DATE 5/5/06	REV. A	TITLE SCHEMATIC DIAGRAM A9-A40 HVAC
						DRAWN SC		
						CHK'D		
						PROJECT NO.		
					ABB Inc.	SHEET 1 OF 1	SIZE A	DRAWING NUMBER D 2401 3002-029