

Accessories for A/AF/AL & AE contactors



CAL5-11



CA5-10

Auxiliary contact blocks – Standard

Positioning	Maximum number of contact blocks	Contact Description	Catalog number	List price
Front mounting (single pole)	4 blocks: A9 – A26 AE9 – AE26 AL9 – AL26	1 N.O. 1 N.C.	CA5-10 CA5-01	\$ 15
	5 blocks: A30, A40, AE30, AE40, AL30, AL40 6 blocks: A45 – A110 AE45 – AE110 AF45 – AF110		1 N.O. Early make 1 N.C. Late break	
Front mounting (4 pole)	1 block: A9 – A26-40-00 A30 – A110 AE9 – AE110	4 N.O. 3 N.O. & 1 N.C. 2 N.O. & 2 N.C. 4 N.C. 2 N.O./2 N.C.Ⓢ	CA5-40E CA5-31E CA5-22E CA5-04E CA5-11/11E	30
	1 block: A9 – A40-30-10 AL9 – AL40-30-10		3 N.O. & 1 N.C. 2 N.O. & 2 N.C. 1 N.O. & 3 N.C. 4 N.C. 4 N.O. 2 N.O./2 N.C.Ⓢ	
Side mounting (2 pole)	2 blocks: A9 – A75, AE9-AE45 1 block: AE50 – AE75, AL9 – AL40	1 N.O. & 1 N.C.	CAL5-11	
	1 block: A/AE/AF95 – A/AE/AF110		CAL18-11	
	2 blocks: A145 – A300, AF145-AF2050 2 blocks: A145 – A300, AF145-AF2050		1 N.O. & 1 N.C. (inside L or R) 1 N.O. & 1 N.C. (outside, L or R)	

Auxiliary contact blocks – Front mounting, switching low voltage and low current

Positioning	Maximum number of contact blocks	Contact Description	Degree of protection	Catalog number	List price
Front mounting (single pole)	4 blocks: A9 – A26 AE9 – AE26 AL9 – AL26	1 N.O. 1 N.C.	IP40 IP40	CE5-10D0.1 CE5-01D0.1	\$ 38
				1 N.O. 1 N.C.	
Front mounting (single pole)	5 blocks: A30, A40, AE30, AE40, AL30, AL40 6 blocks: A45 – A110 AE45 – AE110 AF45 – AF110	1 N.O. 1 N.C. 1 N.O. 1 N.C.	IP67 IP67 IP67 IP67	CE5-10W0.1 CE5-01W0.1	42
				CE5-10W2 CE5-01W2	

Ⓢ Includes 1 N.O. & 1 N.C. overlapping

Accessories for A/AF/AL & AE contactors

Across the line
contactors

1



TP40DA



VE5-1



VM300H



LK75-L

LK75-F

LK110

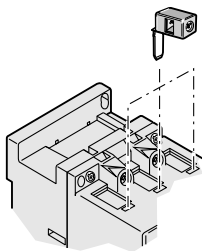

Pneumatic timers

Mounting on	Timing range	Contacts		Catalog number	List price
		N.O.	N.C.		
A9 – A75	On delay 0.1 – 40 s	1	1	TP40DA	\$ 108
AE9 – AE75	On delay 10 – 180 s	1	1	TP180DA	
AL9 – AL40	Off delay 0.1 – 40 s	1	1	TP40IA	
	Off delay 10 – 180 s	1	1	TP180IA	

Interlocks for two horizontally mounted contactors – A9 - A110

Feature	Mounting on	Contacts		Catalog number	List price
		N.O.	N.C.		
Mechanical/electrical	A/AE/AL9 – A/AE/AL40	–	2	VE5-1	\$ 45
Mechanical/electrical	A45 – A110	–	2	VE5-2 ^①	45
Mechanical	A/AE/AL9 – A/AE/AL40	–	–	VM5-1	21

Interlocks for two horizontally mounted contactors – A95 - AF1250 contactors

Feature	Left contactors	Right contactors	Catalog number	List price
Mechanical	A210 – A300	AF400 – AF460	VM300/460H	130
Mechanical	AF400 – AF1250	AF400 – AF1250	VM750H	150

Interlocks for two vertically mounted contactors – A95 - AF1250 contactors

Feature	Top contactor	Bottom Contactor	Catalog number	List price
Mechanical	A210 – A300	AF400 – AF460	VM300/460V	250
Mechanical	AF400 – AF1250	AF400 – AF1250	VM750V	270

Interlocks for two horizontally mounted contactors – AF1350 - AF2050 contactors

Feature	Left contactor	Right Contactor	Catalog number	List price

Auxiliary lead terminals

Connections	Mounting on	Catalog number	List price
Connects from side	A50 – A75	LK75-L	\$ 15
Connects from top	A50 – A75	LK75-F	15
Connects from side	A95 – A110	LK110	23



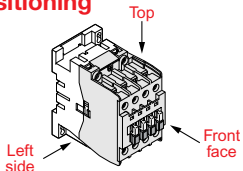

^① Use type VE 5-2 for mechanical and electrical interlocking between A30/A40 and A50 - A75 contactors.

Accessories

Possible accessory combinations for A contactors

Positioning 	Accessories – Front face mounting			Accessories – Side mounting		
	Auxiliary contacts 1 – pole 4 – pole		Pneumatic timers	Auxiliary contacts	Electrical or mechanical interlock ^①	
	CA5-10 or CA5-01	CA5-40 or CA5-22 or CA5-31	TP – D or TP – I	CAL 5-11 CAL18-11 CAL18-11B	VE5-1 or VM 5-1	VE 5-2 VM300H VM300/460H VM750H

Configurations of accessories are different depending on whether front or side mounted.

N Contactor relays A and AE Contactors	Accessories – Front mounting					Accessories – Side mounting		
	Type	Main poles	Built-in auxiliary contacts	Auxiliary contact blocks 1-pole CA5-	4-pole CA5-	TP - A Pneumatic timer block	Auxiliary contact Blocks 2-pole CAL5-11, CAL18-11	Interlock units
								
A9 – A26	- 3 0 - 1 0			1 to 4 CA5- 1-pole blocks	OR 1 CA5- 4-pole block	OR 1 TP - A block	+ 1 to 2 CAL5-11 blocks	OR 1 VM/E 5-1 block + 1 CAL5-11 block
A9 – A26	- 3 0 - 0 1 ①			1 to 4 CA5- 1-pole blocks	OR 1 CA5- 4-pole block	OR -	OR 1 CAL5-11 block	OR 1 VM/E 5-1 block + 1 CAL5-11 block
A9 – A26	- 4 0 - 0 0			1 to 4 CA5- 1-pole blocks	OR 1 CA5- 4-pole block	OR -	OR 1 CAL5-11 block	OR 1 VM/E 5-1 block + 1 CAL5-11 block
A9 – A26	- 2 2 - 0 0 ①			1 to 4 CA5- 1-pole blocks	OR 1 CA5- 4-pole block	OR -	OR 1 CAL5-11 block	OR 1 VM/E 5-1 block + 1 CAL5-11 block
AE9 – AE26	- 3 0 - 0 0			-	-	-	+ 1 to 2 CAL5-11 blocks	OR 1 VM/E 5-1 block + 1 CAL5-11 block
AL9 – AL26	- 3 0 - 1 0			1 to 5 CA5- 1-pole blocks	OR 1 CA5- 4-pole block + 1 CA5- 1-pole block	OR 1 TP - A block + 1 CA5- 1-pole block	+ 1 to 2 CAL5-11 blocks	OR 1 VM/E 5-1 block + 1 CAL5-11 block
AL9 – AL26	- 3 0 - 0 1			1 to 5 CA5- 1-pole blocks	OR 1 CA5- 4-pole block + 1 CA5- 1-pole block	OR -	OR 1 CAL5-11 block	OR 1 VM/E 5-1 block + 1 CAL5-11 block
AL9 – AL16	- 4 0 - 0 0			1 to 5 CA5- 1-pole blocks	OR 1 CA5- 4-pole block + 1 CA5- 1-pole block	OR -	OR 1 CAL5-11 block	OR 1 VM/E 5-1 block + 1 CAL5-11 block
AL9 – AL16	- 2 2 - 0 0			1 to 5 CA5- 1-pole blocks	OR 1 CA5- 4-pole block + 1 CA5- 1-pole block	OR -	OR 1 CAL5-11 block	OR 1 VM/E 5-1 block + 1 CAL5-11 block
AL26	- 4 0 - 0 0			1 CA5- 1-pole block	-	-	+ 1 to 2 CAL5-11 blocks	OR 1 VM/E 5-1 block + 1 CAL5-11 block
AL26	- 2 2 - 0 0			1 CA5- 1-pole block	-	-	+ 1 to 2 CAL5-11 blocks	OR 1 VM/E 5-1 block + 1 CAL5-11 block
A9 – A16	- 3 0 - 2 2			1 to 6 CA5- 1-pole blocks	OR 1 CA5- 4-pole block + 2 CA5- 1-pole blocks	OR 1 TP - A block + 2 CA5- 1-pole blocks	+ 1 to 2 CAL5-11 blocks	OR 1 VE5-2 block + 1 CAL5-11 block
A9 – A26	- 3 0 - 3 2			1 to 6 CA5- 1-pole blocks	OR 1 CA5- 4-pole block + 2 CA5- 1-pole blocks	OR 1 TP - A block + 2 CA5- 1-pole blocks	+ 1 to 2 CAL5-11 blocks	OR 1 VE5-2 + CAL5-11
A30, A40	- 3 0 - 1 0			1 to 6 CA5- 1-pole blocks	OR 1 CA5- 4-pole block + 2 CA5- 1-pole blocks	OR 1 TP - A block + 2 CA5- 1-pole blocks	+ 1 to 2 CAL5-11 blocks	OR 1 VE5-2 block + 1 CAL5-11 block
A30, A40	- 3 0 - 0 1			1 to 6 CA5- 1-pole blocks	OR 1 CA5- 4-pole block + 2 CA5- 1-pole blocks	OR 1 TP - A block + 2 CA5- 1-pole blocks	+ 1 to 2 CAL5-11 blocks	OR 1 VE5-2 + CAL5-11
AE30, AE40	- 3 0 - 1 0			1 to 6 CA5- 1-pole blocks	OR 1 CA5- 4-pole block + 2 CA5- 1-pole blocks	OR 1 TP - A block + 2 CA5- 1-pole blocks	+ 1 to 2 CAL5-11 blocks	OR 1 VE5-2 + CAL5-11
AE30, AE40	- 3 0 - 0 1			1 to 6 CA5- 1-pole blocks	OR 1 CA5- 4-pole block + 2 CA5- 1-pole blocks	OR 1 TP - A block + 2 CA5- 1-pole blocks	+ 1 to 2 CAL5-11 blocks	OR 1 VE5-2 + CAL5-11
AE30, AE40	- 3 0 - 1 0			1 to 6 CA5- 1-pole blocks	OR 1 CA5- 4-pole block + 2 CA5- 1-pole blocks	OR 1 TP - A block + 2 CA5- 1-pole blocks	+ 1 to 2 CAL5-11 blocks	OR 1 VE5-2 + CAL5-11
AE30, AE40	- 3 0 - 0 1			1 to 6 CA5- 1-pole blocks	OR 1 CA5- 4-pole block + 2 CA5- 1-pole blocks	OR 1 TP - A block + 2 CA5- 1-pole blocks	+ 1 to 2 CAL5-11 blocks	OR 1 VE5-2 + CAL5-11
A30, A40	- 3 0 - 3 2			2 CA5- 1-pole blocks	-	-	+ 1 to 2 CAL5-11 blocks	OR 1 VE5-2 block + 1 CAL5-11 block
A50 – A75	- 3 0 - 0 0			1 to 6 CA5- 1-pole blocks	OR 1 CA5- 4-pole block + 2 CA5- 1-pole blocks	OR 1 TP - A block + 2 CA5- 1-pole blocks	+ 1 to 2 CAL5-11 blocks	OR 1 VE5-2 block
A45 – A75	- 4 0 - 0 0			1 to 6 CA5- 1-pole blocks	OR 1 CA5- 4-pole block + 2 CA5- 1-pole blocks	OR 1 TP - A block + 2 CA5- 1-pole blocks	+ 1 to 2 CAL5-11 blocks	OR 1 VE5-2 block
A45, A75	- 2 2 - 0 0 ②			1 to 6 CA5- 1-pole blocks	OR 1 CA5- 4-pole block + 2 CA5- 1-pole blocks	OR 1 TP - A block + 2 CA5- 1-pole blocks	+ 1 to 2 CAL5-11 blocks	OR 1 VE5-2 block
A95, A110	- 3 0 - 0 0			1 to 6 CA5- 1-pole blocks	OR 1 CA5- 4-pole block + 2 CA5- 1-pole blocks	OR 1 TP - A block + 2 CA5- 1-pole blocks	+ 1 to 2 CAL5-11 blocks	OR 1 VE5-2 block
A50 – A75	- 3 0 - 2 2			2 CA5- 1-pole blocks	-	-	+ 1 to 2 CAL5-11 blocks	OR 1 VE5-2 block + 1 CAL5-11 block
A95, A110	- 3 0 - 2 2			2 CA5- 1-pole blocks	-	-	+ 1 to 2 CAL5-11 blocks	OR 1 VE5-2 block + 1 CAL5-11 block
AE50 – AE75	- 3 0 - 0 0			1 to 6 CA5- 1-pole blocks	OR 1 CA5- 4-pole block + 2 CA5- 1-pole blocks	OR 1 TP - A block + 2 CA5- 1-pole blocks	+ 1 to 2 CAL5-11 blocks	OR 1 VE5-2 block
AE45 – AE75	- 4 0 - 0 0			1 to 6 CA5- 1-pole blocks	OR 1 CA5- 4-pole block + 2 CA5- 1-pole blocks	OR 1 TP - A block + 2 CA5- 1-pole blocks	+ 1 to 2 CAL5-11 blocks	OR 1 VE5-2 block
AE45, AE75	- 2 2 - 0 0 ②			1 to 6 CA5- 1-pole blocks	OR 1 CA5- 4-pole block + 2 CA5- 1-pole blocks	OR 1 TP - A block + 2 CA5- 1-pole blocks	+ 1 to 2 CAL5-11 blocks	OR 1 VE5-2 block
AE95, AE110	- 3 0 - 0 0			1 to 6 CA5- 1-pole blocks	OR 1 CA5- 4-pole block + 2 CA5- 1-pole blocks	OR 1 TP - A block + 2 CA5- 1-pole blocks	+ 1 to 2 CAL5-11 blocks	OR 1 VE5-2 block
A50 – A75	- 3 0 - 1 1			1 to 6 CA5- 1-pole blocks	OR 1 CA5- 4-pole block + 2 CA5- 1-pole blocks	OR 1 TP - A block + 2 CA5- 1-pole blocks	+ 1 to 2 CAL5-11 blocks	OR 1 VE5-2 block
AE50, AE75	- 3 0 - 1 1			1 to 6 CA5- 1-pole blocks	OR 1 CA5- 4-pole block + 2 CA5- 1-pole blocks	OR 1 TP - A block + 2 CA5- 1-pole blocks	+ 1 to 2 CAL5-11 blocks	OR 1 VE5-2 block
A95, A110	- 3 0 - 1 1			1 to 6 CA5- 1-pole blocks	OR 1 CA5- 4-pole block + 2 CA5- 1-pole blocks	OR 1 TP - A block + 2 CA5- 1-pole blocks	+ 1 to 2 CAL5-11 blocks	OR 1 VE5-2 block
AE95, AE110	- 3 0 - 1 1			1 to 6 CA5- 1-pole blocks	OR 1 CA5- 4-pole block + 2 CA5- 1-pole blocks	OR 1 TP - A block + 2 CA5- 1-pole blocks	+ 1 to 2 CAL5-11 blocks	OR 1 VE5-2 block
A145 – AF2050	- 3 0 - 0 0			-	-	-	1 to 2 CAL18-11 blocks + 1 to 2 CAL18-11B blocks	OR 1 CAL18-11 block + 1 CAL18-11B block + VM300H or VM300/460H or VM750H interlock

Contactor mounting configurations (standard from factory)

Auxiliary contacts are mounted on the contactor in the following order:

- Left – 1st
- Right – 2nd
- Top – 3rd (L to R)

① In mounting position 5 (see page 1.36), there should be no more than 2 "N.C." front-mounted auxiliary contacts – The CAL 5-11 side-mounted blocks offer additional "N.C." contacts.

② Whatever the mounting position (see page 1.36), there should be no more than 2 "N.C." front-mounted auxiliary contacts – The CAL 5-11 side-mounted blocks offer additional "N.C." contacts.

Accessories

Auxiliary contact block technical data

CA5/CAL5-11/CAL18-11/CC5

Across the line
contactors

1

Types	1-pole CA5, 4-pole CA5 2-pole CAL5-11 and 1-pole CC5		CAL18-11 CAL18-11B
Standards	IEC 947-5-1 and EN 60947-5-1		
Rated insulation voltage U_i according to IEC 947-5-1	V	690	690
according to UL/CSA	V	600	690
Rated operational voltage U_e	~ V	24 to 690	
Conventional thermal current I_{th}	A	16	
Rated operational current I_e in AC-15 acc. to IEC 947-5-1	24 to 127 V 220 to 240 V 380 to 440 V 500 to 690 V	A A A A	6 4 3 2
in DC-13 acc. to IEC 947-5-1	24 V 48 V 72 V 125 V 250 V	A A A A A	6 2.8 1 0.55 0.3
Connecting terminals (delivered in open position. Screws of unused terminals should be tightened).	M 3.5 (+,-) pozidriv 2 screw with cable clamp		
Connecting capacity	1 or 2 x mm ²		
• Rigid solid	1 to 4		
• Flexible with cable end	1 x mm ² 2 x mm ²	0.75 to 2.5 0.75 to 2.5	
Mechanical durability	cycles	10 million, A9 - A75;	5 million, A/AF95 - A/AF185; 3 million, A/AF210 - AF750; 0.5 million, AF1350 & AF1650
Max. switching frequency	cycles/h	3600	
Electrical durability	See curve below		
Max. switching frequency	cycles/h	1200	
Rated making capacity	10 x I_e AC-15		
Rated breaking capacity	10 x I_e AC-15		
Rated short-time withstand current I_{cw} q = 40°C	1 s 0.1 s	A A	100 140
Min. switching capacity	17 V / 1 mA		24V / 50 mA
Short-circuit protection - gG (gI) fuses	A	10	
Power loss per pole at 6 A	W	0.15	
Degree of protection according to IEC 529, IEC 144, DIN 40 050 and NFC 20-010	IP 20		

CAL18

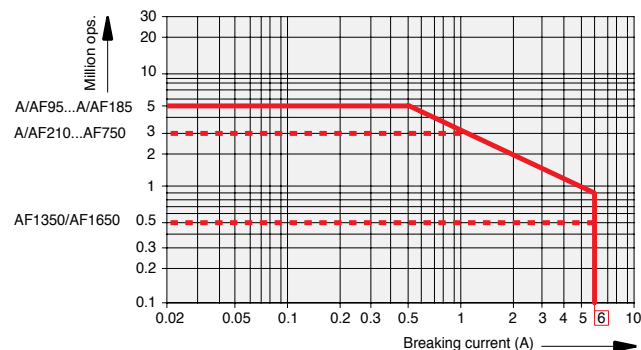

Electrical durability

AC-15 according to IEC 947-5-1

making current: $10 \times I_e$ where $\cos \varphi = 0.7$ and U_e

breaking current: I_e where $\cos \varphi = 0.4$ and U_e

The curves opposite show the electrical durability of the auxiliary contact blocks according to breaking current I_c .

These curves have been plotted for resistive and inductive loads up to 690 V, 40 to 60 Hz.

CA5, CAL5

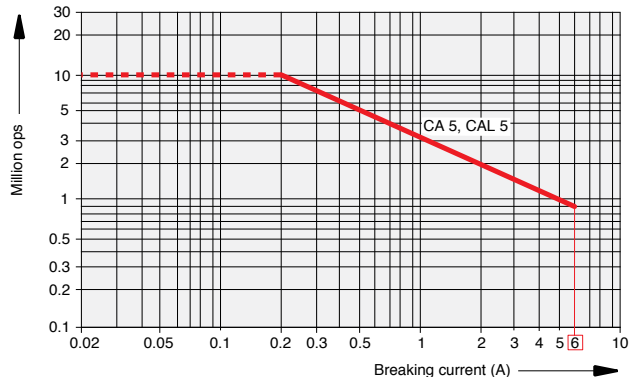

Accessories

Auxiliary contact block technical data

CE5

Auxiliary contact blocks for switching low level voltage and current

Types		CE5-10D0.1 CE5-01D0.1 CE5-10W0.1 CE5-01W0.1 Version 100 mA	CE5-10DZ CE5-01DZ CE5-10WZ CE5-01WZ Version 2 A
Standards		IEC 947-5-1 and EN 60947-5-1	
Approvals		UL / CSA	
Rated insulation voltage U_i according to IEC 947-5-1	V	250	250
according to UL/CSA	V	125	250
Rated operational voltage U_e	V	125	250
Rated operational current I_e in AC-15 or AC-14 acc. to IEC 947-5-1	A	0.1	2
in DC-12 acc. to IEC 947-5-1	A	0.1	2
24 V	A	0.1	0.5
60 V	A	0.1	0.2
110 V	A	0.1	0.1
220 V	A	0.1	
Minimal switching		3 V / 1 mA	17 V / 1 mA
Reliability for the minimal switching		10 ⁻⁸	
Connecting terminals		M3.5 (+,-) posidriv 2 screw with cable clamp	
Connecting capacity • Rigid solid • Flexible with cable end		1 ou 2 (1...4) mm ² 1 ou 2 (0.75... 2.5) mm ²	
Short circuit protection		100 mA	10 A
Degree of protection according to IEC529, IEC 144, DIN 40 050, NFC 20-010	IP 20		
Mounting		Front mounting on contactors: A, AE, TAE9...110, AL, AF, GA, N, NE	
Dimensions		Identical to those of CA5 single pole	

Accessories

Surge suppressors for A/AE/AL/EK contactors

Across the line
contactors

1

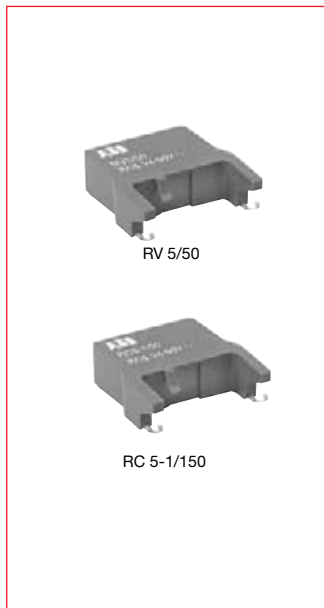

Surge suppression device

Mounting on	Voltage range	Catalog number	List price
AE9 to AE110 AL9 to AL40	12 – 32 VDC	RT5/32	\$ 30
	25 – 65 VDC	RT5/65	
	50 – 90 VDC	RT5/90	
	77 – 150 VDC	RT5/150	
	150 – 264 VDC	RT5/264	
A9 to A110; AE9 to AE110 AL9 to AL40	24 – 50 VAC/VDC	RV5/50	\$ 30
	50 – 133 VAC/VDC	RV5/133	
	110 – 250 VAC/VDC	RV5/250	
	250 – 440 VAC/VDC	RV5/440	
A9 to A40	24 – 50 VAC	RC5-1/50	\$ 30
	50 – 133 VAC	RC5-1/133	
	110 – 250 VAC	RC5-1/250	
	250 – 440 VAC	RC5-1/440	
A45 to A300	24 – 50 VAC	RC5-2/50	\$ 30
	50 – 133 VAC	RC5-2/133	
	110 – 250 VAC	RC5-2/250	
	250 – 440 VAC	RC5-2/440	
EK110 to EK210	24 – 48 VAC	RC-EH250/48	\$ 26
	110 – 415 VAC	RC-EH250/415	
EK370 to EK550	48 – 110VAC	RC-EH800/110	
EK110 to EK550	24 – 125VDC	RC-EH800/110	
EK370 to EK550	220 – 600VAC	RC-EH800/600	

Technical data

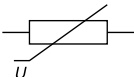
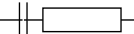
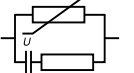
Type	Control circuit	Opening time growth factor	Residual overvoltage or clipping voltage	Remarks
RT 5 /... transil diode 	32	2.5 to 3	50 V 100 V 150 V 210 V 390 V	Advantages <ul style="list-style-type: none"> • Good energy absorption • Unpolarized system • Simple, reliable system Drawback <ul style="list-style-type: none"> • A certain delay on drop out which does not however reduce contactor breaking capacity.
	65			
	90			
	150			
	264			
Varistor 	RV 5/...	1.1 to 1.5	132 V 270 V 480 V 825 V	Advantages <ul style="list-style-type: none"> • High energy absorption; good damping • Unpolarized system Drawback <ul style="list-style-type: none"> • Clipping as from U_{vdr}, thus voltage front up to this point
	50			
	133			
	440			
RC 5-1/... or RC 5-2/... RC-EH 300/... 	see table above	1.2 to 3	2 to 3 x U_c	Advantages <ul style="list-style-type: none"> • Very fast clipping • Attenuation of steep fronts and thus of high frequencies • No operating delays
	AC			
Varistor + RC 	RC-EH ...	1.1 to 1.5	205 V 1100 V	Advantages <ul style="list-style-type: none"> • High energy absorption: good damping • Unpolarized system • The RC system damps the voltage front under the U_{vdr}^* threshold.
	800/110 800/600			

* U_{vdr} = Varistor operating voltage (voltage dependent resistor), tolerance $\pm 10\%$

Accessories

Surge suppressors for A/AE/AL/EK contactors

General information

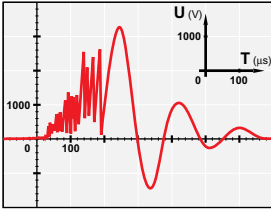

General

The operation of inductive circuits causes overvoltages, in particular on opening of the contactor coil.

The electromagnetic energy stored by the coil during contactor closing is restored on opening in the form of surges, the slope and amplitude of which may rise to several kilovolts. A number of drawbacks are observed ranging from interference on the electronic devices to breakdown of insulators and even destruction of certain sensitive components.

The graph opposite reproduces the oscillogram showing voltage discharges at the terminals of a 42V/50Hz coil without peak clipping. The coil was switched by 8 series-connected poles of a contactor relay.

Following a burst of discharges with a very steep slope a damped oscillation emerges with a peak value of 3500V.

Overvoltage factor

The overvoltage factor k is defined as the ratio of the maximum overvoltage peak value \hat{U}_s to the peak value \hat{U}_c of the coil rated control voltage U_c :

$$k = \frac{\hat{U}_s \text{ max.}}{\hat{U}_c}$$

in DC:

$$k = \frac{\hat{U}_s \text{ max.}}{U_c}$$

or in AC:

$$k = \frac{\hat{U}_s \text{ max.}}{U_c \sqrt{2}}$$

For example the following is obtained for the above graph: $k = \frac{3500}{42 \sqrt{2}} \approx 60$

Surge suppressors

To guard against the harmful effects of these overvoltages, ABB has developed a range of surge suppressors designed to reduce the k factor defined above and to limit or even completely eliminate the high pre-damping voltage frequencies.

Each case is different, but the technical data tolerances and the generous sizing of parts have enabled us to reduce the number of variants.

We have chosen the following solutions: transil diodes, varistors and RC blocks.

Note: A varistor is a resistor whose value increases to a very large extent when a certain voltage is applied at its terminals.

Wiring diagrams

Transil diode

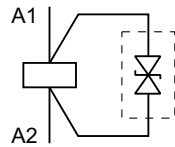

Varistor (only)

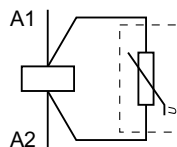

RC type

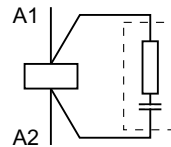

Varistor + RC

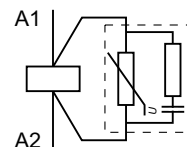

General technical data

The housings and impregnation resins of the surge suppressors are made of flame-resistant materials in accordance with the UL 94 standard.

These systems are not polarized, i.e. d.c. operated devices do not have to be connected in a specific direction.

- Operating temperature: -20 to +70 °C
- Connection to the coil terminals (parallel mounting)
 - For **RT 5**, **RV 5**, **RC 5-1** and **RC 5-2**: clip-on for both fixing and connection.
- Mounting:
 - **RT 5**, **RV 5** and **RC 5**: clipped onto the top part of the contactor base. This mounting method prevents any projections and change in contactor dimensions.
 - **RC-EH**: glued to the top part of the contactor base.

Accessories

Interface relays for A contactors

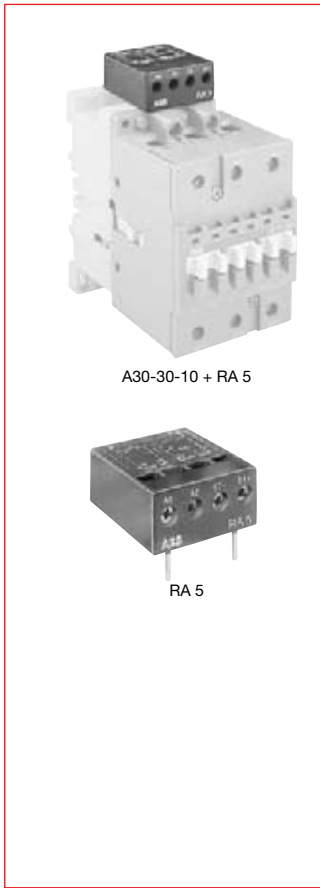

Interface relays

Mounting on contactor types	Control voltage U_c	Coil voltages	Catalog number	List price
N, A9 – A110	24 VDC	24 – 250V, 50, 60 Hz	1SBN 060 300 R1000	\$ 75

NOTE: The interface relays provided for the A contactors can also be used for UA, UA..., RA and GA types.

Application

RA 5-1 interface relays are designed to receive 24 VDC signals delivered by PLC's or other sources with a low output power and restore them with sufficient power to operate the coils of the relevant A9 - A110 contactors or the N control relays.

Description

RA5 interface relays are made up of a miniature electromechanical relay equipped with a N.O. contact and with a low consumption 24 VDC coil.

The interface relay coil is controlled by the PLC while the N.O. contact ensures switching of the power contactor.

Coil switching gives rise to overvoltages which have adverse effects on the electronic devices, insulators and, more generally, on component lifetime. The RA 5-1 is equipped with surge suppressors:

- on the 24 VDC relay coil via a diode
- on the power contactor coil via a varistor.

Furthermore, the RA 5-1 are protected against relay pole reversal by a diode inserted between the E1 and E2 input terminals.

Connection

The "E1+" and "E2-" input terminals must be connected, according to their polarity, to the PLC output.

The RA 5 is equipped with two terminal pads for connection to the A1 and A2 terminals of the contactor coil. This coil is supplied between the A0 and A2 terminals of the RA 5.

Mounting

- RA5: terminal pads clamped inside the contactor coil terminals.

RA 5-1 interface relay for the A 9 – A 110 contactors and N control relays

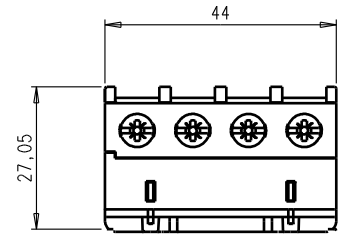
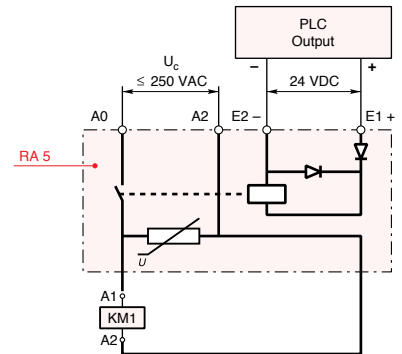

Accessories

Interface relay technical data

General technical data

Compliance with standards		IEC 60255-5
Rated insulation voltage U_i according to IEC 60947-4-1	V a.c.	250
Permissible ambient temperature:		
– for free air operation:		
– at $U_c = 24$ V d.c. (between E1 and E2)	°C	-25 ... +70
– from 0.85 to 1.1 U_c	°C	-25 ... +55
– for storage	°C	-40 ... +70
Climatic withstand		Complies with that of associated contactors
Operating altitude	m	≤ 3000
Mounting position		No limitation
Fixing		Using the contactor A1 and A2 terminal connecting parts
Connecting terminals (delivered in open position)		M3.5 (+,-) pozidriv 2 screws with cable clamp
Connecting capacity (min. ... max.)		
– rigid solid	2 x mm²	1 ... 4
– flexible with cable end	2 x mm²	0.75 ... 2.5
Tightening torque		
– recommended	Nm	1.00
– max.	Nm	1.20
Degree of protection according to IEC 60947-1 / EN 60947-1 and IEC 60529 / EN 60529		Protection against direct contact in acc. with EN 50274 RA5-1 wired and mounted on the associated contactor

Working data

Surge suppression:		
– for contactor coil		Varistor
– for interface relay coil		Diode
Protection against polarity reversal between terminals E1 and E2		Diode
Interface relay operating time	ms	Closing and drop-out ≤ 10
Total operating time, interface relay + contactor:		
– between energization and:		
N.O. contact closing	ms	20 ... 37
N.C. contact opening	ms	17 ... 32
– between de-energization and:		
N.O. contact opening	ms	17 ... 25
N.C. contact closing	ms	20 ... 28

Electrical input data

Control voltage (E1 and E2 terminals) U_c		
– rated value	V d.c.	24
– max. range at ambient temperature 20 °C	V d.c.	19 ... 30
Max. consumption for $U_c = 24$ V d.c., $\theta = 20$ °C	W	0.3
"0" status (relay open) for U_c	V d.c.	≤ 2.4
or I_c	mA	< 1
"1" status (relay closed) for U_c	V d.c.	≥ 19
Max. short supply interruption immunity time	ms	2

Electrical output data

Switching voltage (A0 and A2 terminals)	V a.c.	≤ 250
Electrical durability million of operating cycles		2 (600 cycles/h) on A 9 ... A 75 contactors or N... contactor relay 0.5 (600 cycles/h) on A 95 and A 110 contactors

Accessories for A/AE/AL/AF contactors

Across the line
contactors

1



Terminal lug kits (Set of 3)

Wire range	For contactor	Catalog number	List price
6 – 300 MCM	A145 – A185	ATK185	\$ 45
4 – 400 MCM	A210 – A300	ATK300	68
(2) 4-500 MCM	A210 – A300	ATK300/2	110
(2) 2/0 – 500 MCM	AF400 – AF580	ATK580/2	150
(3) 2/0 – 500 MCM	AF580 – AF1250	ATK750/3	225
(4) 4/0 – 500 MCM	AF1350	ATK1350/4	235
(4) 1/0 – 750 MCM	AF1350 – AF2050	ATK1650/4	335
(6) 1/0 – 750 MCM	AF1350 – AF2050	ATK1650/6	560

Contact kits

For contactors	Catalog number	List price
3 Pole		
A/AE/AF50	ZL50	\$ 113
A/AE/AF63	ZL63	135
A/AE/AF75	ZL75	158
A/AE/AF95	ZL95	225
A/AE/AF110	ZL110	255
A/AF145	ZL145	300
A/AF185	ZL185	420
A/AF210	ZL210	525
A/AF260	ZL260	855
A/AF300	ZL300	1020
AF400	ZL400	1716
AF460	ZL460	2434
AF580	ZL580	3795
AF750	ZL750	3960
AF1250	ZL1250	5280
AF1350	ZL1350	4255
AF1650	ZL1650	4890
AF2050	ZL2050	6290
4 Pole		
A/AE45	ZLT45	150
A/AE50	ZLT50	150
A/AE75	ZLT75	210
3 Pole		
UA50	ZLU50	150
UA75	ZLU75	215
UA95	ZLU95	306
UA110	ZLU110	347

Mechanical latches

For contactors	Catalog number	List price
A9 - A75, AE45 - AE75, & AL9 - AL40	WB75A-Δ	\$ 84

Δ - Coil voltage suffix. Refer to Coil Voltage Selection chart and substitute the desired coil voltage suffix for the Δ.

Coil voltage selection chart – mechanical latches for A, AE & AL contactors

50 Hz (AC/DC)	60 Hz (AC)	Voltage code	50 Hz (DC)	60 Hz (AC)	Voltage code
24	24 – 28	01	220 – 230	220 – 255	06
42	42 – 48	02	230 – 240	230 – 277	05
48	48 – 55	03	380 – 415	380 – 440	07
110	110 – 127	04	415 – 440	440 – 480	08

Range: WB75A for contactors A9 – A75, AL9 – AL40, AE45 – AE75 and control relays N and NL.

Description: WB75A block: contains a mechanical latching device with electromagnetic impulse unlatching (AC or DC) or manual unlatching. Captive screw type connecting terminals, built-in cable clamps, M 3.5 (=, -) posidrive 1 screw with screwdriver guidance, delivered untightened and protected against accidental direct contact.

Operation: After closing, the contactor continues to be held in the closed position by the latching mechanism should the supply voltage fail at the contact coil terminals.

Contact opening can be controlled:

- Electrically by an impulse* (AC or DC) on the WB75A block coil. The coil is not designed to permanently energized.
- Manually by pressing the pushbutton on the front face of the WB75A block.

Mounting: WB75A is clipped onto the front face of the contactor.

Identification markers

Mounting on	Coil voltage	Catalog number	List price
A/AE/AL/AF9 – A/AE/AL/AF110	Pack of 50	BA5-50	\$ 15

Accessories for A/AE/AL/AF contactors Coils & coil voltage codes

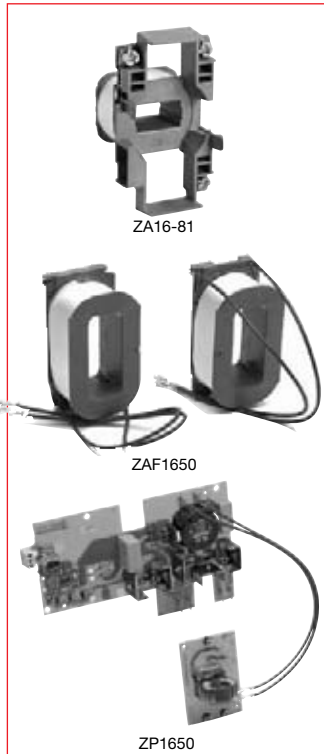

Coils – AC operated

For contactors	Catalog number	List price
A9 – A16	ZA16-Δ	\$ 24
A26 – A40	ZA40-Δ	30
A45 – A75	ZA75-Δ	57
A95 – A110	ZA110-Δ	60
A145 – A185	ZA185-Δ	150
A210 – A300	ZA300-Δ	180

Coils – DC operated

AE9 – AE16	ZAE16-Δ	24
AE26 – AE40	ZAE40-Δ	30
AE45 – AE75	ZAE75-Δ	57
AE95 – AE110	ZAE110-Δ	90
Auxiliary including an insertion contact and a varistor for DC operated contactors AE95 – AE110	CCL18-01	45

Coils – AC/DC operated (coil and printed circuit board except ZAF1650)

AF45 – AF75	ZAF75-Δ	120
AF95, AF110	ZAF110-Δ	165
AF145 – AF185	ZAF185-Δ	200
AF210 – AF300	ZAF300-Δ	240
AF400, AF460	ZAF460-Δ	450
AF580, AF750, AF1250	ZAF750-Δ	525
AF1350, AF2050 (Set of 2 coils only)	ZAF1650-Δ	920

Printed circuit board – AC/DC operated

AF1350 – AF2050	ZP1650	1620
-----------------	--------	------

Δ – Coil voltage suffix. Refer to Coil Voltage Selection charts below and substitute the desired coil voltage code for the Δ.

Coil voltage selection – AC operated for A9 – A300; UA26 – UA110

VAC (50Hz)	VAC (60Hz)	Voltage Code
24	24	81
26	28	16
28	32	17
42	42	82
48	48	83
60	60	73
100	100 – 110	74 ②
110	110 – 120	84
110 – 115	115 – 127	89 ③
120	140	29
125 – 127	150	30
175	208	34
190	220	36
200	200 – 220	75 ②
220 – 230	230 – 240	80
230 – 240	240 – 260	88
230 – 240	277	42
230/400	–	62 ①
–	230/400	63 ①
380 – 400	400 – 415	85
400 – 415	415 – 440	86
–	480	51
440	500	53
500	600	55
550	–	56
660 – 690	–	58

Coil voltage selection – DC operated for AE contactors

VDC	Voltage code AE contactors
12	80
24	81
42	82
48	83
50	21
60	84
75	85
110	86
125	87
220	88
240	89
250	38

Coil voltage selection – AC/DC operated for AF50 – AF2050

VAC & VDC 40-60 Hz	Suffix Code
24 – 60 VDC	68 ④
20 – 60 VDC	72 ⑤
48 – 130 VAC/VDC	69
100 – 250 VAC/VDC	70 ⑦
250 – 500 VAC/DC	71 ⑥

① Only for A9 – A16.
② Not for A145 – A300
③ A145 – A300 at 60 Hz, 115V only
④ AF400 – AF1250, DC only
⑤ AF45 – AF300
⑥ AF400 – AF750 only
⑦ Only option for AF2050 – AF1650

Accessories for EK contactors Coils & coil voltage codes

Across the line
contactors

1

Coils – AC & DC operated

Contactor size	AC Coils		DC Coils	
	Catalog number	List price	Catalog number	List price
EK110, EK150	KH210-Δ	\$ 200	KH210-Δ	\$ 260
EK175, EK210	KH300-Δ	240	KH300-Δ	320
EK370, EK550	KH800-Δ	580	KH800-Δ	700

Δ – Coil voltage suffix. Refer to the Coil Voltage Selection chart and substitute the desired coil voltage suffix for the Δ. AC and DC operated contactors DO NOT have the same magnet structure. Therefore, DC coils will not fit on an AC magnet structure and vice versa.

Coil voltage selection – AC operated for EK110 – EK550

VAC (50Hz)	VAC (60Hz)	Voltage Code
–	24	F
24	–	N
–	48	G
110	120	1
–	208	B
–	240	2
220 – 230	–	J
–	380	Z
380 – 400	440	3
400 – 415	–	M
–	480	4
500	–	5
–	600	6

Consult factory if other voltages are required.

Coil voltage selection – DC operated for EK110 – EK550

VDC	Voltage Code
24	Y
48	W
110	P
125	Q
220	R
440	T

Consult factory if other voltages are required.

Accessories for A/AE/AL/AF contactors

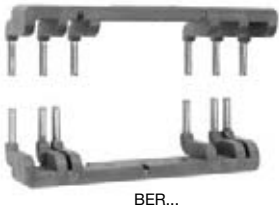

BER...

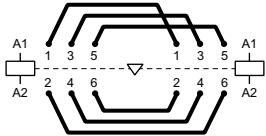

BEM circuit diagram

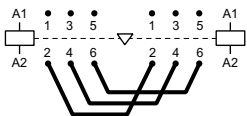

BES110 connection diagram



BEY...



BEY...

Connection kits for reversing

Mounting on 3 pole contactors	Catalog number	List price
A/AE/AL9 – A/AE/AL16	BER16V	\$ 35
A/AE/AL26 – A/AE/AL40	BER40V	49
A/AE/AF50 – A/AE/AF75	BEM75-30	165
A/AE/AF95, A/AE/AF110	BEM110-30	180
A/AF145 – A/AF185	BEM185-30	260
A/AF210 – A/AF300	BEMA300-30	470
AF400 – AF460	BEM460-30	850
AF580 – AF750	BEM750-30	1200

Application

Connections between the main poles of **two 3 pole contactors** mounted side by side so that they operate as reversing contactors.

Description

The connection kits for reversing contactors are made up of three reversing connections and three phase to phase connections.

- BER16V – Molded plastic, solid copper bars
- BER40V – Molded plastic, solid copper bars
- BEM75 and 110-30 – Insulated, solid copper bars

Connection kits for phase to phase

Mounting on 3 pole contactors	Catalog number	List price
A/AE/AF50, A/AE/AF75	BES75-30	\$ 75
A/AE/AF95, A/AE/AF110	BES110-30	90
A/AF145 – A/AF185	BES185-30	130
A/AF210 – A/AF300	BESA300-30	200
AF400 – AF460	BES460-30	425
AF580 – AF750	BES750-30	650

The connection kit for phase to phase contactors is made up of three phase to phase bus bars.

Connection kits for wye-delta starters

Mounting on contactors		Catalog number	List price
Line and delta contactor	Wye contactor		
A9	A9	BEY16V-2	\$ 46
A12	A9		
A16	A12		
A26	A16	BEY26-2	76
A30	A26	BEY40-2	76
A40	A26		
A50	A30	BED50U	165
A63	A40		
A75	A50		
A95	A75	BED75U	180
A110	A95	BED95U	195
A145	A110	BED110U	225
A185	A145	BED145U	250
A210	A185	BED185U	290
A260/A300	A185	BED210U	375
	A210	BED300U	500
AF400/AF460	A260/A300	BED400U	850
AF460	AF400	BED460U	900
AF580	AF400/AF460	BED580U	1250
AF750	AF580	BED750U	1450

Application

Connections between the main poles of a wye-delta starter.

Description

- Three line contactor/wye contactor connections – line side.
- Three wye contactor/delta contactor connections – load side.
- The shorting connection for the “S” contactor.

BEY16V-2, BEY26-2, BEY40-2 – Molded plastic, solid copper bars

BED50U thru BED750U – Insulated, solid copper bars.

The above connection sets allow a mechanical interlock unit to be mounted between the wye and delta contactors if required.

Accessories for A/AE/AL/AF contactors

Across the line
contactors

1

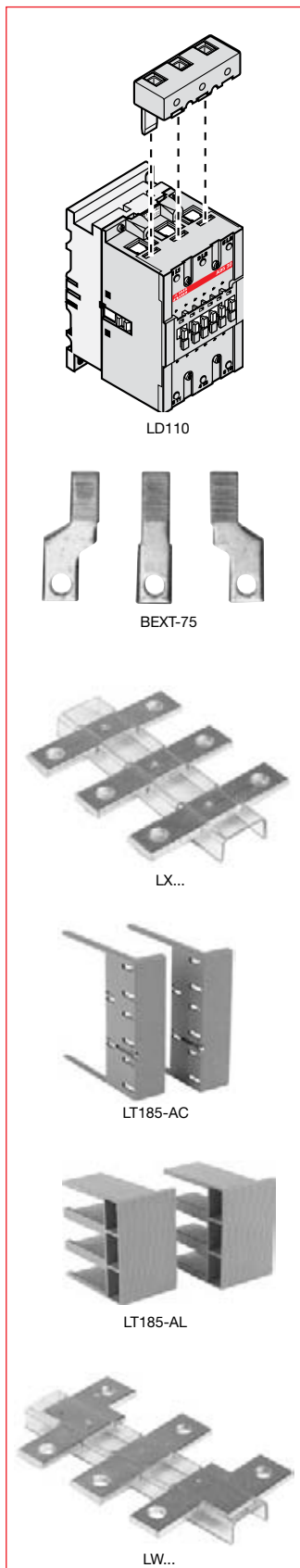

Additional terminal blocks

Mounting on 3 pole contactors	Wire range	Catalog number	List price
A/AE/AL9 – A/AE/AL16 (set of 2)	16 – 6	LD-16	\$ 20
A/AE/AL26 (set of 2)	14 – 6	LD-26	22
A/AE/AL30 – A/AE/AL40	12 – 4	LD-40	26
A/AE/AF50 – A/AE/AF75	10 – 2	LD-75	28
A/AE/AF95 – A/AE/AF110	8 – 1	LD-110	30

Utilization – The LD series terminal block is designed to increase the connection capacity of the contactor on which it is mounted. The LD 75 and LD110 terminal blocks are mounted in the three independent apertures located above the built-in connectors.

Terminal extensions

Mounting on contactors	Catalog number	List price
A/AE/AF50 – A/AE/AF75	BEXT-75	\$ 15
A/AE/AF95, A/AE/AF110	LW-110	15
A/AF145 – A/AF185	LX185	90
A/AF210 – A/AF300	LX300	140
AF400 – AF460	LX460	195
AF580 – AF750	LX750	225

Application

They are designed to increase the width of the contactor terminal pads to allow larger connectors to be mounted.

Description

Terminal extension sets contain 3 bars.

Terminal shrouds – two pieces

For contactor	Catalog number	List price
A/AF145 – A/AF185 for flush mount	LT185-AC	\$ 10
A/AF145 – A/AF185 for extended mount	LT185-AL	
A/AF145 – A/AF185 for shorting bar LY... between A(F)145 / A(F)185 & TA200DU	LT185-AY	
A/AF210 – A/AF300 for flush mount	LT300-AC	
A/AF210 – A/AF300 for extended mount	LT300-AL	
A/AF210 – A/AF300 for shorting bar LY300	LT300-AY	20
AF400 – AF460 for flush mount	LT460-AC	
AF400 – AF460 for extended mount	LT460-AL	
AF580 – AF1250 for flush mount	LT750-AC	
AF580 – AF1250 for extended mount	LT750-AL	

Terminal enlargements

For contactor	Catalog number	List price
A/AF95 – A/AF110	LW110	\$ 95
A/AF145 – A/AF185	LW185	120
A/AF210 – A/AF300	LW300	130
AF400 – AF460	LW460	295
AF580 – AF750	LW750	355
AF1250	LW1250	375

Arc chutes

For contactor	Catalog number	List price
A/AF145 – A/AF185	ZW185	\$ 130
A/AF210 – A/AF300	ZW300	180
A/AF400 – A/AF460	ZW460	190
A/AF580 – A/AF750	ZW750	230
AF1350 – AF1650	ZW1650	315

Accessories for A/AE/AF contactors



BEA185/S3/S4



BEAD185D/S3/S4



BEA185H/S4



LP185



LY...

Vertical connection bars between contactor and MCCB – three bars

MCCB	For contactor	Catalog number	List price
T1	A/AE/AF50 – A/AE/AF75	BEA75/T1	\$ 85
T3	A/AE/AF95 – A/AE/AF110	BEA110/T3	95
T3	A/AF145 – A/AF185	BEA185/T3	60
S3, S4	A/AF145 – A/AF185	BEA185/S3/S4	60
T4	A/AF145 – A/AF185	BEA185/T4	60
T4	A/AF210 – A/AF300	BEA210/T4	70
T5	A/AF210 – A/AF300	BEA300/T5	75
T5	A/AF400 – A/AF460	BEA400/T5	95
T5	A/AF580 – A/AF750	BEA750/T5	115
S5	A/AF210 – A/AF300	BEA300/S5	75
S5 ^①	AF400 – AF460	BEA400/S5	95
S6	AF400 – AF750	BEA750/S6	115

Vertical connection bars between contactor and MCCB – three bars

MCCB	For contactor	Catalog number	List price
S3, S4	A/AF145 – A/AF185	BEA185D/S3/S4	\$ 70
S4	A/AF210 – A/AF300	BEA210D/S4	80
S5	A/AF210 – A/AF300	BEA300D/S5	85
S5	AF400 – AF460	BEA400D/S5	105
S6	AF400 – AF750	BEA750D/S6	125

To be used when power take off is needed (IP00) or with other bus bars. (EX: Reversing, IP20)

Horizontal connection busbars between contactor and MCCB – three bars

MCCB	For contactor	Catalog number	List price
S3, S4	A/AF145 – A/AF185	BEA185H/S4	\$ 150
S4	A/AF210 – A/AF300	BEA210H/S4	220
S5	A/AF210 – A/AF300	BEA300H/S5	220
S5	AF400 – AF460	BEA400H/S5	435
S6	AF400 – AF460	BEA460H/S6	660
S6	AF580 – AF750	BEA750H/S6	670

Shorting bars, 2 pole

For contactor	Catalog number	List price
A/AF145 – A/AF185	LP185	\$ 35
A/AF210 – A/AF300	LP300	50
AF400 – AF460	LP460	50
AF580 – AF750	LP750	50

Shorting bars, 3 pole

For contactor	Catalog number	List price
A/AE45 – A/AE/AF75	LF75	\$ 40
A/AE/AF95 – A/AE/AF110	LY110	40
A/AE/AF145 – A/AE/AF185	LY185	40
A/AE/AF210 – A/AE/AF300	LYA300	60
AF400 – AF460	LY460	60
AF580 – AF750	LY750	60

① Not for use with flange handles.

Accessories for A contactors TE5S electronic timer for wye-delta starters



TE5S-*

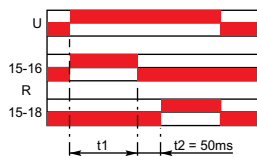

Chart

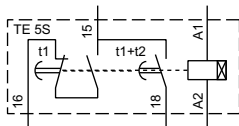

Equivalent diagram

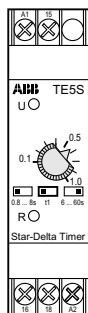

Front face

Electronic timer

For contactors	Rated control voltage U_c V	Packing piece	Unit weight kg	Catalog number	List price
A9 – AF750	24 AC/DC	1	0.080	TE5S-24	\$ 120
	110 – 120 AC	1	0.080	TE5S-120	
	220 – 240 AC	1	0.080	TE5S-240	
	380 – 440 AC	1	0.080	TE5S-440	

Application

Utilization

When used in wye-delta starters, the **TE5S** lags the wye connection and provides a lapse of 50 ms before the switchover to the delta connection.

Description

According to the type of device chosen, the electronic circuit has a 24 VAC/VDC, 110 – 120 VAC or 220 – 230 VAC supply. An output relay with reversing contact ensures high current switching. A two-position switch allows selection of one of the two time delay ranges: 0.8 to 8 s or 6 to 60 s. The 0.1 to 1.0 adjustable knob allows an initial setting without steps within the previously selected range which can then be adjusted using a stopwatch.

Note: We recommend that you allow for temperature drift for the final adjustment of the time delay setting. Drift: – 0.2% per °C. For example, a setting made at 20 °C will yield a time delay shorter by 7% at 55 °C in an enclosure. (– 0.2% per °C i.e. – 0.2 x 35 = – 7%).

The TE5S, which is not affected by these settings, establishes a fixed “lapse” of 50 ms between the opening of contact 15 – 16 and the closing of contact 15 – 18. It is this time delay that prevents from arc short-circuit during wye to delta switching.

Operation

On energization, the green U indicator light (voltage applied) comes on. Contact 15 – 16 then immediately moves to the closed position.

Count-down of the programmed time immediately commences.

When the time delay has elapsed, contact 15 – 16 opens and at the same time the 50 ms lapse, t_2 , begins after which contact 15 – 18 moves to the closed position. The yellow R indicator light comes on.

On de-energization, the U and R indicator lights go out and, after the 250 ms resetting time, the device is ready for a new cycle.

Mounting

Mounts on 35mm DIN rail.

Accessories for A contactors TE5S electronic timer for wye-delta starters, technical data

Technical Data

Types	TE5S-24	TE5S-120	TE5S-240	TE5S-440
Compliance with standards	IEC 60947-5-1, EN 60947-5-1			
Rated insulation voltage U_i according to IEC 60947-5-1	V		440	
Rated operational voltage U_e according to IEC 60947-5-1	V d.c.		24	–
	V a.c.		24 ... 240	440
Conventional free air thermal current I_{th}	A		10	
Rated operational current I_e acc. to IEC 60947-5-1				
AC-15	24-120 V a.c.	A	5	–
	220-240 V a.c.	A	4	–
	380-440 V a.c.	A	–	3
DC-13	24 V d.c.	A	4	–
Short-circuit protection - gG type fuses	A		10	
Rated supply voltage U_c	V d.c.		24	–
	V a.c.		24	110 ... 120
– Rated frequency limits	Hz		48 ... 63	
– Supply voltage range	0.85 ... 1.1 U_c			
– Overvoltage protection	Built-in varistor			
– Load factor	%		100	
– Average consumption	– in d.c.	W	0.7	–
	– in a.c.	VA	1.5	3.5
			6.5	12.5
Time delay range (t_1) selected by switch	s		0.8 ... 8 and 6 ... 60	
– Temperature drift	% per °C		–0.2	
– Mechanical setting accuracy	±15 % of the setting range			
– On-load reiteration accuracy under constant conditions	±2 % after 1 million operating cycles			
Minimum time lapse (t_2)	ms		50	
Min. time lapse after 1 million operating cycles	ms		40	
Resetting time (maximum)	ms		250	
Front panel display:	– green indicator light		Energization	
	– yellow indicator light			Output relay activated
Permissible air temperature				
– for operation	°C		–25 ... +60	
– for storage	°C		–40 ... +85	
Vibration withstand acc. to IEC 60068-2-6, EN 60068-2-6	3 g from 10 to 300 Hz in the 3 directions			
Shock withstand acc. to IEC 60068-2-27, EN 60068-2-27	20 g / 11 ms in directions A and C 15 g / 11 ms in direction B			
Electrical durability	in millions of op. cycles		1	
Mechanical durability	in millions of op. cycles		5	
On-load maximum switching frequency	cycles/h		720	600
Fixing on mounting rail acc. to IEC/EN 60715	35 x 7.5 or 35 x 15			
Connecting terminals	(+, -) pozidriv 1 screw			
Connecting capacity				
– rigid solid	1 or 2 x mm ²		1 ... 2.5	
– flexible with cable end	1 or 2 x mm ²		0.75 ... 2.5	
Tightening torque	Nm		0.6 ... 0.8 max.	
Degree of protection according to IEC 60947-1 / EN 60947-1 and IEC 60529 / EN 60529	Terminals		IP 20	

Accessories

Terminal markings

CA/CC/CAL/CCL auxiliary contacts

One pole auxiliary contacts

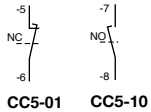
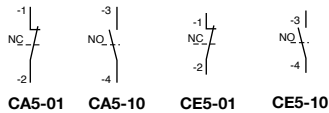

Two pole auxiliary contacts

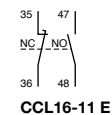
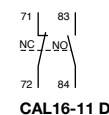
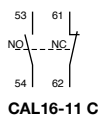
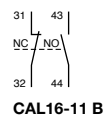
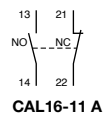
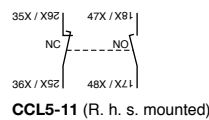
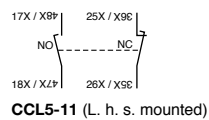
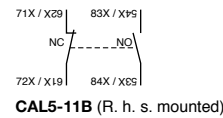
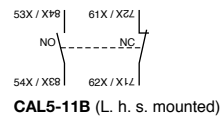
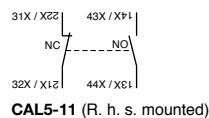
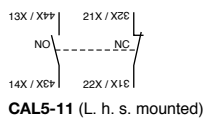

Four pole auxiliary contacts

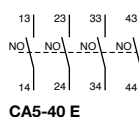
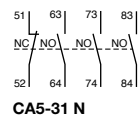
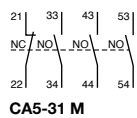
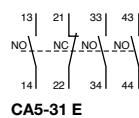
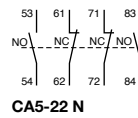
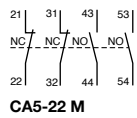
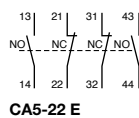
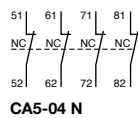
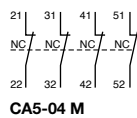
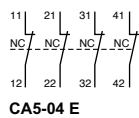

—

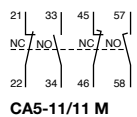
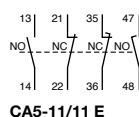
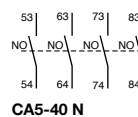

Accessories

Terminal markings & positioning for A/UA contactors

Standard devices without addition of auxiliary contacts

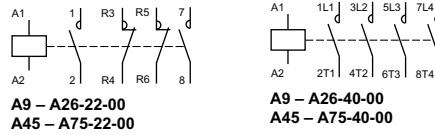
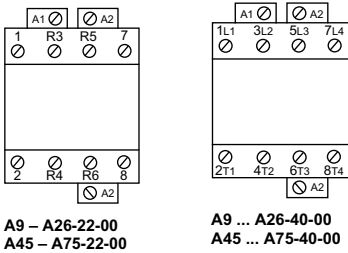
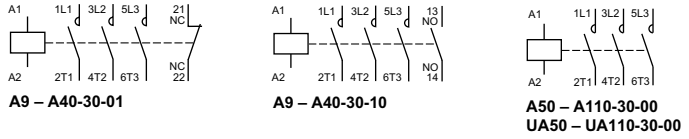
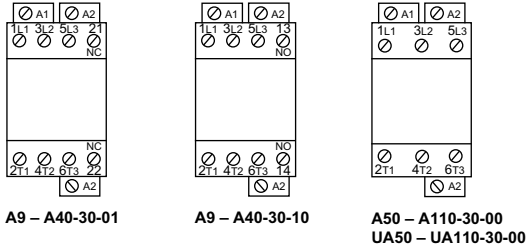

Standard 3 pole devices with factory mounted auxiliary contacts

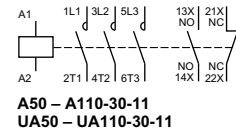
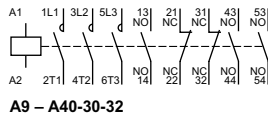
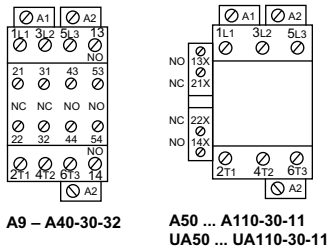
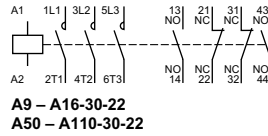
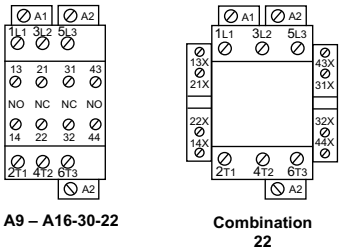

Other possible contact combinations with auxiliary contacts added by the user

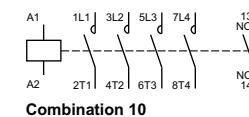
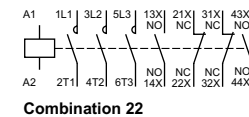
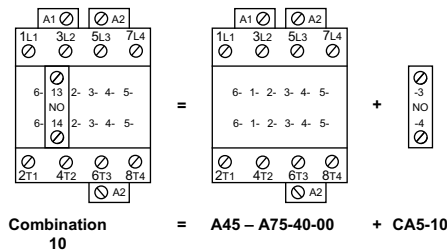
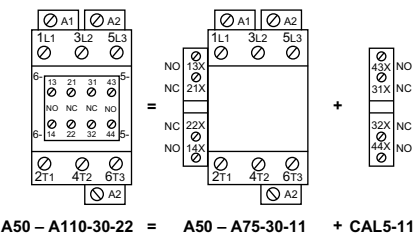
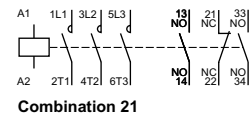
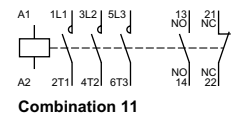
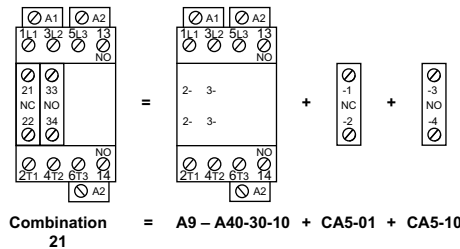
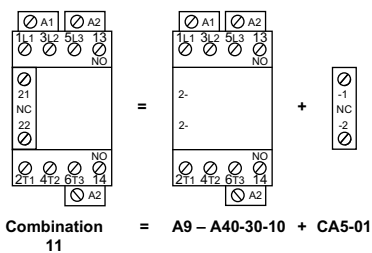

Accessories

Terminal marking and positioning for AE/AL contactors

AE Contactors – D.C. operated

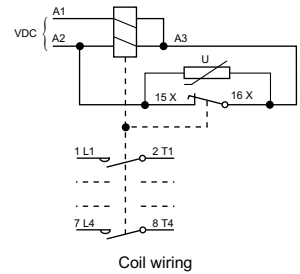
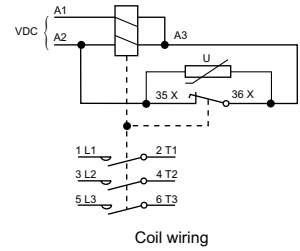
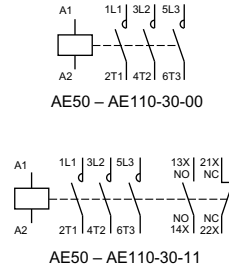
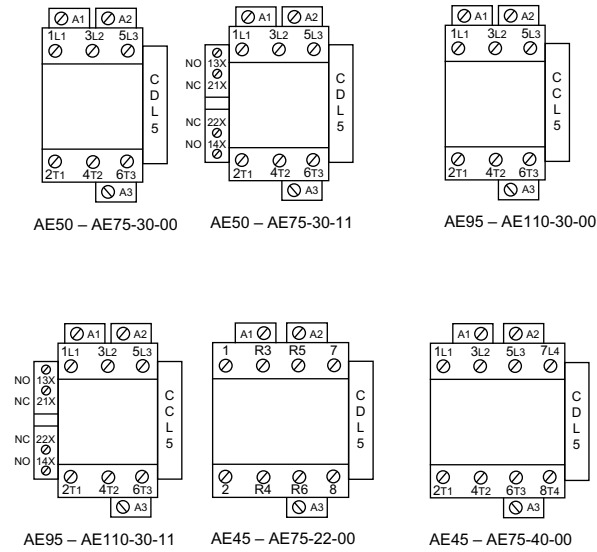

AL Contactors – D.C. operated

Standard devices without addition of auxiliary contacts

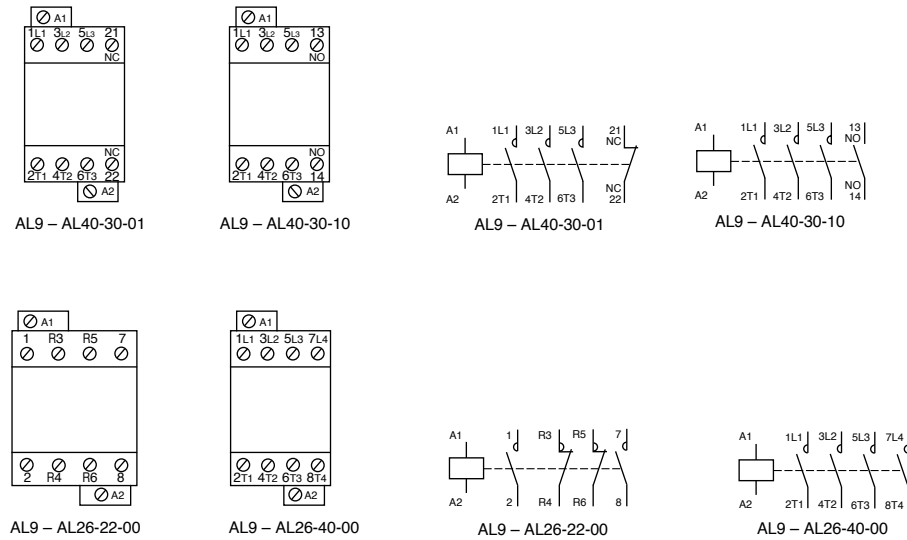

Other possible contact combinations with auxiliary contacts added by the user

