

E220 – E270 Modular DIN rail components

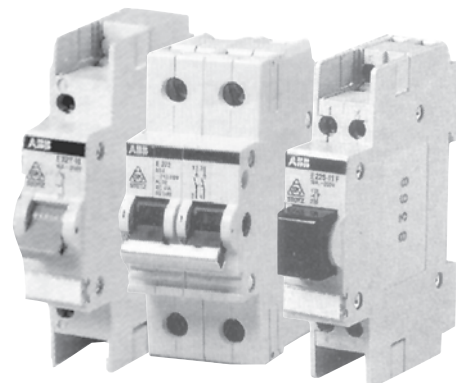

System pro M compact Modular DIN rail components E220 - E270 Series



Description

- Safe connection by box terminals
- Captive screws with Pozidrive slotted head, Pozidrive system, Gr. 1
- Snap-on labels available
- Quick mounting with snap-on clip, easily accessible and detachable at the bottom
- Protection against unintentional direct touch
- System approach for control and circuit protection
- Compact size that dimensionally matches the S2 MCB series
- Control and pilot functions can be along side protective devices
- DIN rail mounted with 45mm front opening
- For use in auxiliary and logic devices
- Provide additional user functions for system control and operation
- Include pushbuttons, indicating lights and selector switches
- ABB System Pro M compatibility
- Most devices are both UL 508 recognized and are IEC compliant
- Labeled with the CE Mark

E221 & E222 Switches, 240VAC 16 & 25A



E221-10

Type	Rated current	Catalog number	List price	Delivery schedule	Suggested order qty's	Weight (Oz.) 1 piece
Switches						
1 N.O. + 1 N.C.	16	E221-11	\$ 90	B	10	2.46
2 N.O. + 2 N.C.	16	E221-22	177			
3 N.O. + 1 N.C.	16	E221-31	177			
1 N.O.	16	E221-10	59	B	10	1.94
2 N.O.	16	E221-20	110			
3 N.O.	16	E221-30	120			
4 N.O.	16	E221-40	159			
1 N.O. + 1 N.C.	25	E222-11	140	B	10	2.47
1 N.O.	25	E222-10	107			
2 N.O.	25	E222-20	141			
3 N.O.	25	E222-30	159			
4 N.O.	25	E222-40	239			

Form "C" switches

1 Change-over contact	16	E221-6	69	B	10	2.12
2 Change-over contacts	16	E221-6/2	125			
1 Change-over contact	25	E222-6	128	B	10	2.12

Form "C" switches (I-O-II, Hand-OFF-Automatic)

1 Pole	16	E221-4	99	B	10	2.12
2 Pole	16	E221-4/2	147			
1 Pole	25	E222-4	150	B	10	2.12

Note: Above devices are UL 508 recognized and IEC certified.
A300 pilot duty UL file # E171252

Delivery Class

- A** - Standard item, stock to 2 weeks lead time
- B** - Stock to 4 weeks lead time
- C** - 6 to 8 week lead time

E225 - E229, E10 Pilot devices

System pro M
Modular DIN rail
components



E225-11F



E227-10E



E233-120/60



E1175



E1175-C

Type	Catalog number	List price	Delivery schedule	Pack units pcs.	Weight (Oz.) 1 piece
Pushbutton, 1 N.O. + 1 N.C. contact					
Grey	E225-11B	\$ 75	A	10	1.94
Red	E225-11C				
Green	E225-11D				
Yellow	E225-11E				
Black	E225-11F				
Blue	E225-11G				

Illuminated pushbutton, 1 N.O. contact with lamp, 120 VAC					
Clear	E227-10B/110	100	A	10	1.94
Red	E227-10C/110				
Green	E227-10D/110				
Yellow	E227-10E/110				
Blue	E227-10G/110				

Pilot light with lamp, 120 VAC					
Clear	E229-B/110	93	A	10	1.59
Red	E229-C/110				
Green	E229-D/110				
Yellow	E229-E/110				
Blue	E229-G/110				

Lamps					
24 VAC/DC	E10/24	24	A	1	0.14
120 VAC/DC	E10/110				
220 VAC/DC	E10/220				

Note: Above devices are UL 508 recognized and IEC certified. UL file # E171252

Special features

- Safe connection via box terminals
- Captive screws with Phillips/Slotted head, Posidriv system, Gr. 1
- Snap-on labels available
- Protection against unintentional touch acc. to DIN VDE 0106 Part 100
- Lenses and pushbuttons in six colors

Elapsed time meter

Type	Catalog number	List price	Delivery schedule	Pack units pcs.	Weight (KG) 1 piece
24 VAC, 60 Hz	E233-24/60	\$ 130	B	1	0.045
120 VAC, 60 Hz	E233-120/60		A		
240 VAC, 60 Hz	E233-240/60		B		

- Non-resettable
 - 100,000 hours (99999.99)
- UL file #171252

Sockets

Type	Catalog number	List price	Delivery schedule	Pack units pcs.	Weight (KG) 1 piece
Socket, 250 VAC, 50/60 Hz Italian standard	E1173	\$ 57	B	1	0.2
Socket, 250 VAC, 50/60 Hz French standard	E1174	\$ 57	B	1	0.2
Socket, 250 VAC, 50/60 Hz Schuko standard	E1175	\$ 57	B	1	0.2
Socket w/cover, 250 VAC, 50/60 Hz Schuko standard	E1175-C	\$ 57	B	1	0.2

Delivery Class

- A** - Standard item, stock to 2 weeks lead time
- B** - Stock to 4 weeks lead time
- C** - 6 to 8 week lead time

Digital meters



DTS7/1



VLMD-1-2

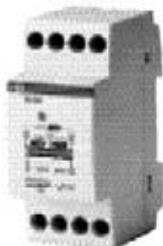

TM15/12

Measuring instruments

Type	Catalog number	List price	Delivery schedule	Pack units pcs.	Weight (KG) 1 piece
Digital timer, 230 VAC, 50/60 Hz	DTS7/1	\$ 422	B	1	0.3
Voltmeter 600 VAC, 50-400 Hz	VLMD-1-2	510	B	1	0.3
Ammeter 15-20-25-40-60A, 250-400-600A, 50-400 Hz	AMTD-1	510	B	1	0.3
Transformer, 230 VAC, 50/60 Hz 4-8-12 VAC sec	TM15/12	135	B	1	0.3

Components for quick mounting onto DIN rails (35mm)

Mounting depth: 68mm
Mounting width: 1, 2, 3 and 4 pole switches = 17.5mm (= 1 module)

E220 Switches, 16 & 25A

Switching capacity: $1.25 I_n$, $1.1 U_n$, $\cos \phi = 0.6$
Short-circuit withstanding capacity: 3 kA, 380V, $\cos \phi = 0.9$
Toggle sealable: In ON and OFF positions
Connection cross-sections: Up to $1 \times 6\text{mm}^2$ or $2 \times 2.5\text{mm}^2$
Rated AC voltage: 240 VAC UL/CSA (E171252)
250/440 VAC IEC

E240/270 Disconnect switches, 45, 63, 80, & 100A

Switching capacity: $1.25 I_n$, $1.1 U_n$, $\cos \phi = 0.3$
Short-circuit withstanding capacity: E240 = 10kA, E270 = 25kA RMS
Connection cross-sections: E240 up to 25mm^2
E270 up to 50mm^2
Rated AC voltage: 240/400/415 VAC

E Series components for quick mounting onto DIN rails (35mm)

Mounting depth: 68mm
Mounting width: 17.5mm (=1 module)
Color: RAL 7035, grey
Connection cross sections: Up to $1 \times 6\text{mm}^2$ or $2 \times 2.5\text{mm}^2$
Rated current: 16A
Rated voltage: 250 VAC IEC
Rated voltage: 240 VAC UL/CSA (E171252)

Terminal markings

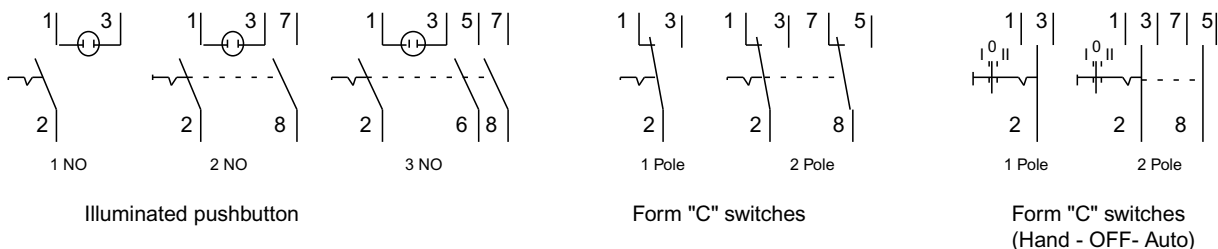
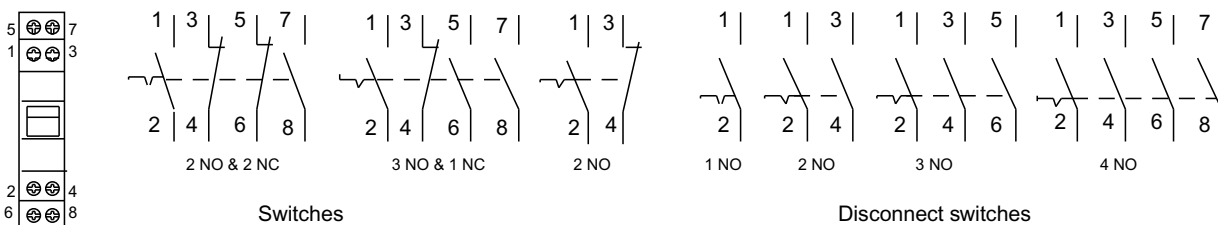

Terminal assignments for pushbuttons and indicator lights

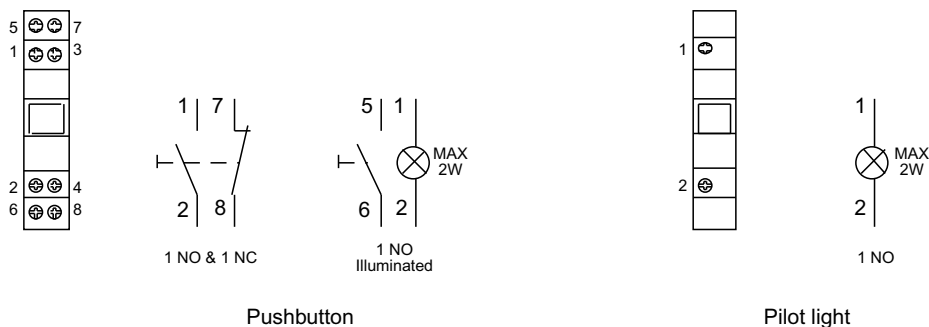

Approximate dimensions

E220

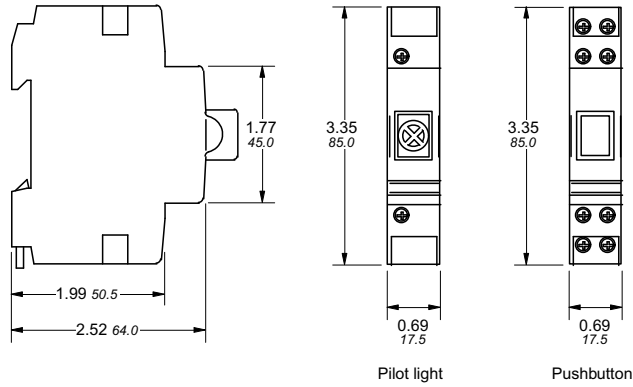

E220, 16 & 25A

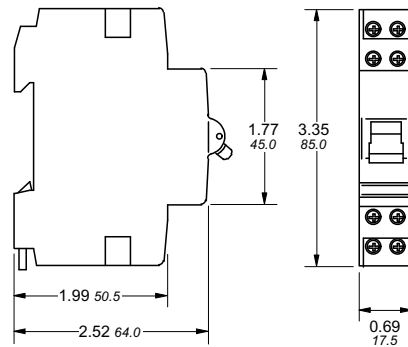

E233

14

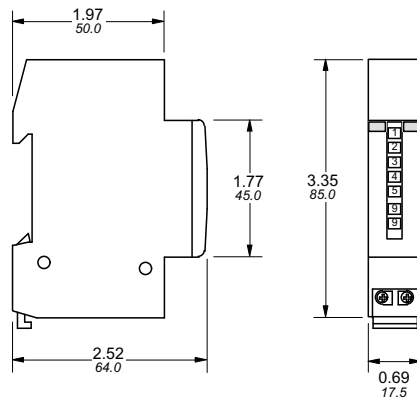

E240/270

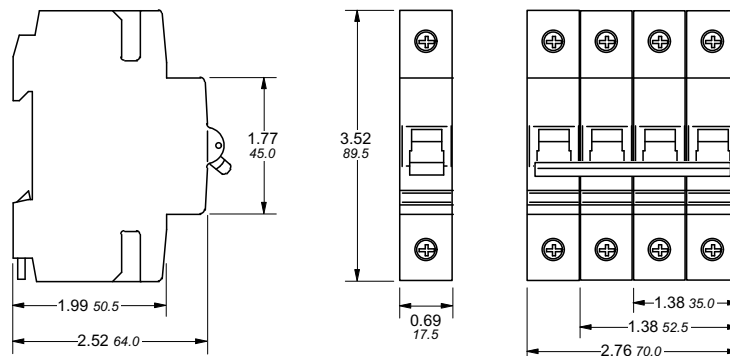

Approximate dimensions

E1173 - E1175

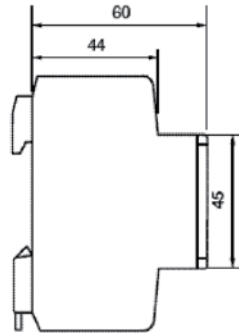
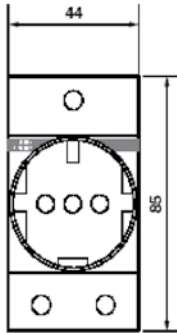

DTS

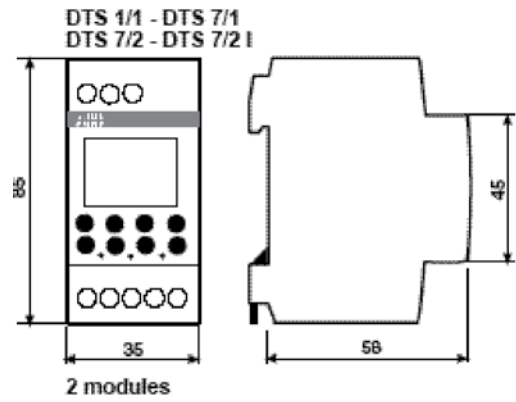

VLMD, AMTD

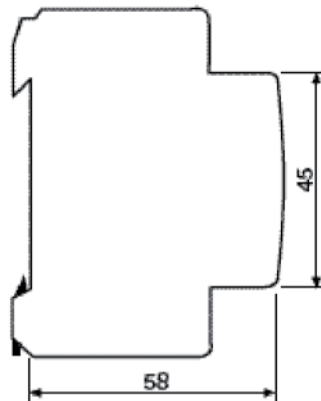
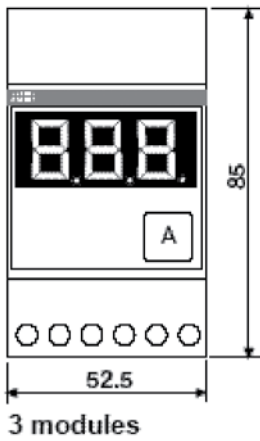

TMS

