

# SafeLine Enclosed Disconnect switches



## SafeLine

Compact, heavy duty

Enclosed disconnect switches

16A – 3150A Non-fusible

30A – 3000A Fusible



SafeLine enclosed disconnect switches are designed to meet customer requirements in terms of safety, ease of installation, space savings and operational convenience. They are available in a wide range of amperage ratings, are UL approved and NEMA rated to satisfy rugged industrial environments.

Disconnect  
switches  
Non-fusible  
Enclosed

## eOT Enclosed manual motor controllers

The eOT series of enclosed manual motor controllers are rotary operated, 3 pole, 600V Hp rated switches, housed in thermoplastic/polycarbonate enclosures suitable for wet and corrosive environments.



### Ordering data

#### NEMA 3R/12

Handle Type	Handle Color	Amp Rating	Auxiliary Contacts	Catalog Number	List Price
Selector	Black	16	--	EOT16U3P3-S	\$ 250
Selector	Black	40	--	EOT32U3P3-S	300
Selector	Black	60	--	EOT45U3P3-S	325
Pistol	Black	80	--	EOT63U3P3-P	355
Selector	Black	16	1 NO	EOT16U3P3-1S	305
Selector	Black	40	1 NO	EOT32U3P3-1S	370
Selector	Black	60	1 NO	EOT45U3P3-1S	405
Pistol	Black	80	1 NO	EOT63U3P3-1P	435
Selector	Red/Yellow	16	--	EOT16U3P3-S1	250
Selector	Red/Yellow	40	--	EOT32U3P3-S1	300
Selector	Red/Yellow	60	--	EOT45U3P3-S1	325
Pistol	Red/Yellow	80	--	EOT63U3P3-P1	355
Selector	Red/Yellow	16	1 NO	EOT16U3P3-1S1	305
Selector	Red/Yellow	40	1 NO	EOT32U3P3-1S1	370
Selector	Red/Yellow	60	1 NO	EOT45U3P3-1S1	405
Pistol	Red/Yellow	80	1 NO	EOT63U3P3-1P1	435

#### NEMA 4/4X

Pistol	Black	16	--	EOT16U3P4-P	\$ 270
Pistol	Black	40	--	EOT32U3P4-P	325
Pistol	Black	60	--	EOT45U3P4-P	365
Pistol	Black	80	--	EOT63U3P4-P	385
Pistol	Black	16	1 NO	EOT16U3P4-1P	335
Pistol	Black	40	1 NO	EOT32U3P4-1P	400
Pistol	Black	60	1 NO	EOT45U3P4-1P	445
Pistol	Black	80	1 NO	EOT63U3P4-1P	475
Pistol	Red/Yellow	16	--	EOT16U3P4-P1	270
Pistol	Red/Yellow	40	--	EOT32U3P4-P1	325
Pistol	Red/Yellow	60	--	EOT45U3P4-P1	365
Pistol	Red/Yellow	80	--	EOT63U3P4-P1	385
Pistol	Red/Yellow	16	1 NO	EOT16U3P4-1P1	335
Pistol	Red/Yellow	40	1 NO	EOT32U3P4-1P1	400
Pistol	Red/Yellow	60	1 NO	EOT45U3P4-1P1	445
Pistol	Red/Yellow	80	1 NO	EOT63U3P4-1P1	475

### Accessories for eOT16 – eOT63

Description	For use on	AC thermal amp rating	AC rated voltage	Catalog number
<b>Auxiliary contacts</b> ②				
NO, mounts on right side of the switch only	eOT16 - 63	10	600	OA1G10
NC, mounts on left side of the switch only		10	600	OA1G01
<b>4th pole</b> ③				
4th pole	eOT16 & eOT32	40	600	OTPS32EP
4th pole, late-break / early-make function		40	600	OTPL32EP
4th pole	eOT45 & eOT63	80	600	OTPS63EP
4th pole, late-break / early-make function		80	600	OTPL63EP

① Due to torque requirements, the eOT63 is equipped with a pistol handle for both 3X/12 & 4/4X versions.

② Maximum number of auxiliary contacts: 2NO + 1NC.

③ Only one additional pole per switch.

# eOT Enclosed manual motor controllers

Approximate dimensions  
eOT16\_ - eOT45U

Disconnect  
switches  
Non-fusible  
Enclosed

## eOT16\_, eOT32\_ (enclosure size 1)

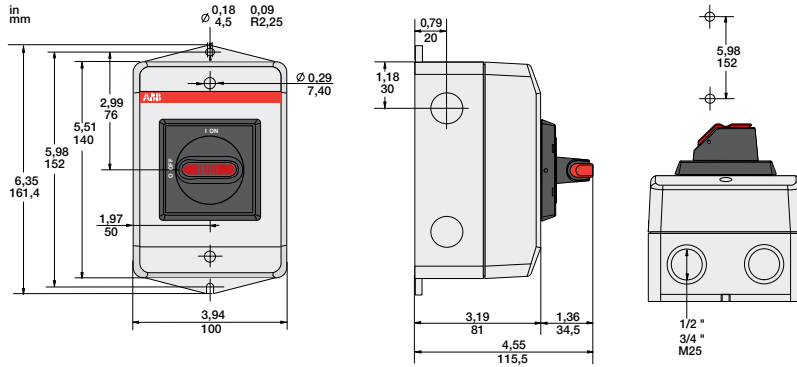

## eOT45U\_ (enclosure size 2 with selector switch)

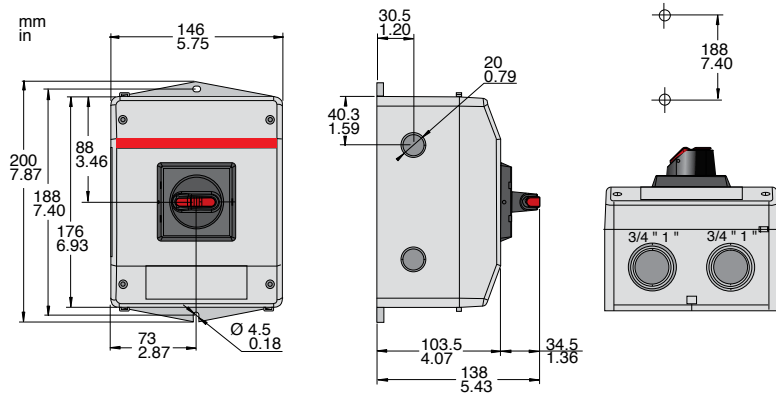

## eOT45U\_ (enclosure size 2 with pistol grip handle)

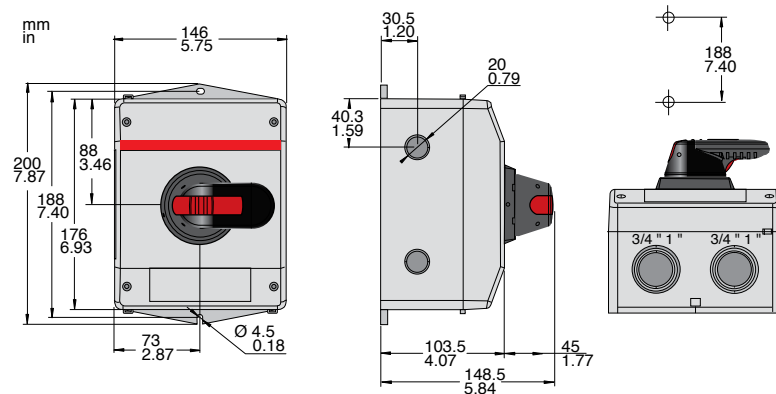

Disconnect  
switches  
Non-fusible  
Enclosed

## eOT Enclosed manual motor controllers

Approximate dimensions  
eOT63\_

### eOT series enclosed manual motor controllers

Approximate dimensions

#### eOT63\_ (enclosure size 3)

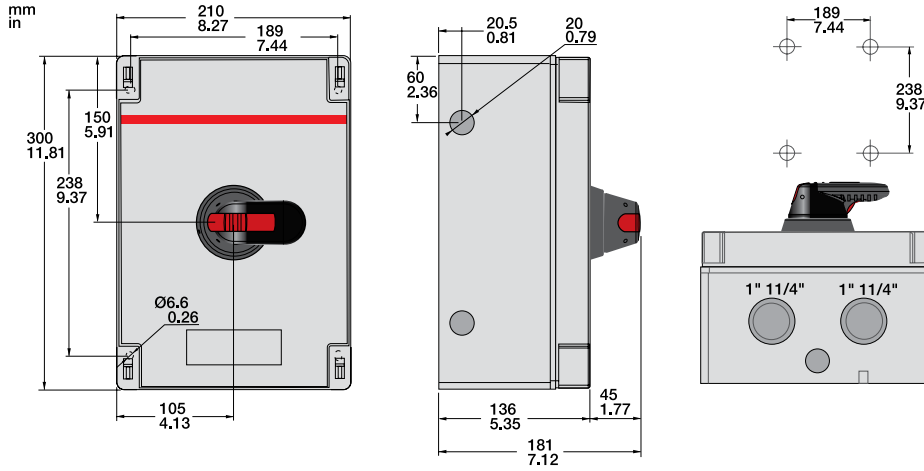

## General information

### Non-fusible and fusible

Disconnect  
switches  
Non-fusible  
Enclosed

#### Non-Fusible

UL Listed to UL 508 and UL 98.  
CSA approved  
IEC rated  
CE marked

Snap on accessories include additional poles, auxiliary contacts, etc.

Enclosures available in plastic, metal, or stainless steel in NEMA 1, 3R, 12, 4X, 7 & 9 environmental categories



Modern appearance

Quick make, quick brake mechanism

Heavy duty disconnect, 600VAC

Extremely compact size

Finger-proof construction. No hazardous exposed parts

3/4/6/8 pole constructions; transfer switches and by-pass switches available

#### Fusible

UL Listed to UL 98 standards.  
CSA approved  
IEC rated  
CE marked

Snap on accessories include fuse monitors, auxiliary contacts, etc.

Enclosures available in plastic, metal, or stainless steel in NEMA 1, 3R, 12, 4X, 7 & 9 environmental categories

Fuse carriers available for US standards, BS, DIN, NFC standard and for various high speed fuse patterns



Modern appearance

Quick make, quick brake mechanism

Heavy duty disconnect, 600VAC, 200kA, I<sub>sc</sub>

Extreme compact size as fuse carriers are decked above contacts

Double contacts enabling feed from any direction and preventing back feed

Finger-proof construction. No hazardous exposed parts

3/4/6/8 pole constructions; transfer switches and by-pass switches available

#### Lockable

Clear position indications:  
I-ON  
O-OFF

Door interlocked when handle padlocked to OFF position

Handle padlockable with up to three padlocks



Door interlocked when handle is in ON position. Door interlock can be defeated by authorized personnel.

Pilot devices can be added

## General information NEMA Environmental ratings

### Introduction

An enclosure is a surrounding case constructed to provide a degree of protection to personnel against accidental contact with the enclosed equipment and to provide a degree of protection to the enclosed equipment against specified environmental conditions.

A brief description of the more common types of enclosures used by the electrical industry relating to their environmental capabilities follows.

Refer to NEMA Standards Publication for more information regarding applications, features and design tests.

Individual NEMA product Standards Publications or third party certification standards may contain additional requirements for product testing and performance.

### Definitions pertaining to nonhazardous locations

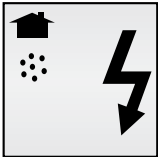

Type 1

Enclosures are intended for indoor use primarily to provide a degree of protection against limited amounts of falling dirt. (NEMA Standard 7-15-1991.)

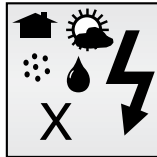

Type 4X

Enclosures are intended for indoor or outdoor use primarily to provide a degree of protection against corrosion, windblown dust and rain, splashing water, hose-directed water and damage from external ice formation. (NEMA Standard 1-10-1979)

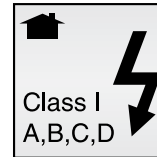

Type 7

Enclosures are intended for indoor use in locations classified as Class I, Groups A, B, C, or D, as defined in the National Electrical Code. (NEMA Standard 7-15-1991.)

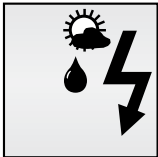

Type 3R

Enclosures are intended for outdoor use primarily to provide a degree of protection against rain, sleet and damage from external ice formation. (NEMA Standard 7-15-1991.)

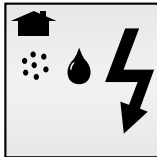

Type 12

Enclosures are intended for indoor use primarily to provide a degree of protection against circulating dust, falling dirt, and dripping noncorrosive liquids. (NEMA Standard 7-15-1991.)

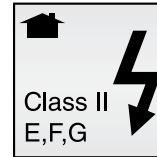

Type 9

Enclosures are intended for indoor use in locations classified as Class II, Groups E, F, or G, as defined in the National Electrical Code. (NEMA Standard 7-15-1991.)

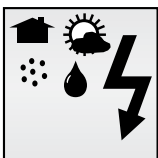

Type 4



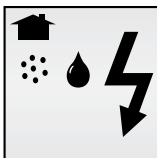

Enclosures are intended for indoor or outdoor use primarily to provide a degree of protection against windblown dust and rain, splashing water, hose-directed water and damage from external ice formation. (NEMA Standard 1-10-1979.)



Type 13

Enclosures are intended for indoor use primarily to provide a degree of protection against dust, spraying of water, oil and noncorrosive coolant. (NEMA Standard 1-10-1979.)

#### Legend

-  – Indoors
-  – Outdoors
-  – Water
-  – Dirt/dust
-  – Corrosion















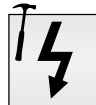
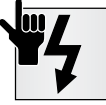
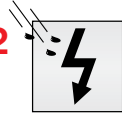

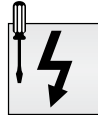
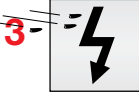
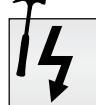
# General information

## IP Environmental ratings

Disconnect  
switches  
Non-fusible  
Enclosed

### IP ratings

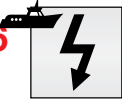
indicate the degree of protection against dust, liquids and impacts. The IP degrees of protection are defined by the French standard NFC 20-010. To rate a device's degrees of protection, the letters IP are followed by up to three numbers. These numbers are defined as follows:

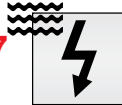
<b>first number</b> protection against solid objects	<b>second number</b> protection against liquids	<b>third number</b> protection against mechanical impacts
<b>IP 0</b>  no protection	<b>IP 0</b>  no protection	<b>IP 0</b>  no protection
<b>1</b>  protected against solid objects over 50mm (e.g. accidental touch by hands.)	<b>1</b>  protected against vertically falling rain or condensation	<b>1</b>  impact 0.225 joule 150g falling from 15cm
<b>2</b>  protected against solid objects over 12mm (e.g. fingers)	<b>2</b>  protected against direct sprays of water up to 15° from vertical	<b>2</b>  impact 0.375 joule 250g falling from 15cm
<b>3</b>  protected against solid objects over 2.5mm (tools & wires)	<b>3</b>  protected against sprays to 60° from vertical	<b>3</b>  impact 0.50 joule 250g falling from 20cm
<b>4</b>  protected against solid objects over 1mm (small tools & small wires)	<b>4</b>  protected against water sprayed from all directions	<b>5</b>  impact 2.00 joule 500g falling from 40cm
<b>5</b>  protected against dust (no harmful deposit)	<b>5</b>  protected against low pressure jets of water from all directions	<b>7</b>  impact 6.00 joule 1.5kg falling from 40cm
<b>6</b>  totally protected against dust	<b>6</b>  protected from strong jets of water (e.g. for use on ship decks)	<b>9</b>  impact 20.00 joule 5 kg falling from 40cm
	<b>7</b>  protected against the effects of immersion between 15cm and 1m	

**Disconnect  
switches**  
Non-fusible  
Enclosed

**3 pole**  
**16A – 3150A**



NF32X-3PB6C



NF63X-3PB6A

**3 Pole, 600V, 16A – 80A**  
**Selector handle**

		NEMA Enclosure type							
		1		3R		4		4X Stainless	
UL general purpose amp rating		Catalog number	List price	Catalog number	List price	Catalog number	List price	Catalog number	List price
UL 508		16	NF161-3PB6C	\$ 185	NF163-3PB6C	\$ 259	Not available with selector handle	Not available with selector handle	
		25	NF251-3PB6C	190	NF253-3PB6C	264			
		40	NF321-3PB6C	205	NF323-3PB6C	279			
		60	NF451-3PB6B	245	NF453-3PB6B	320			
		80	NF631-3PB6A	280	NF633-3PB6A	354			

**3 Pole, 600V, 16A – 3150A**  
**Pistol handle**

		NEMA Enclosure type								
		1		3R		4		4X Stainless		
UL general purpose amp rating		Catalog number	List price	Catalog number	List price	Catalog number	List price	Catalog number	List price	
UL 508		16	NF161-3PB6C	\$ 235	NF163-3PB6C	\$ 309	NF164-3PB6A	\$ 475	NF16X-3PB6C ②	\$ 585
		25	NF251-3PB6C	240	NF253-3PB6C	314	NF254-3PB6A	480	NF25X-3PB6C ②	590
		40	NF321-3PB6C	255	NF323-3PB6C	329	NF324-3PB6A	495	NF32X-3PB6C ②	605
		60	NF451-3PB6B	295	NF453-3PB6B	370	NF454-3PB6B	525	NF45X-3PB6B	635
		80	NF631-3PB6A	330	NF633-3PB6A	404	NF634-3PB6A	550	NF63X-3PB6A	660
UL 98		30	NF301-3PB6C	510	NF303-3PB6C	780	NF304-3PB6C	1090	NF30X-3PB6C	1200
		60	NF601-3PB6C	560	NF603-3PB6C	830	NF604-3PB6C	1140	NF60X-3PB6C	1250
		100	NF1001-3PB6B	610	NF1003-3PB6B	880	NF1004-3PB6B	1190	NF100X-3PB6B	1300
		125	NF1251-3PB6A	1100	NF1253-3PB6A	1400	NF1254-3PB8A	2800	NF125X-3PB8A	3500
		200	NF2001-3PB8B	1300	NF2003-3PB8B	1650	NF2004-3PB8B	3520	NF200X-3PB8B	4400
		400	NF4001-3PB4B	2600	NF4003-3PB4B	2800	NF4004-3PB4B	6400	NF400X-3PB4B	8000
		600	NF6001-3PB7B	4800	NF6003-3PB7B	5000	NF6004-3PB7B	9600	NF600X-3PB7B	12,000
		800	NF8001-3PB4A	8000	NF8003-3PB4A	9400	NF8004-3PB4A	15,200	NF800X-3PB4A	19,000
		1200	NF12001-3PB4A	10,000	NF12003-3PB4A	11,800	NF12004-3PB4A	18,000	NF1200X-3PB4A	22,500
		1600	NF16001-3P8A	19,000	NF16003-3P8A	20,800	NF16004-3P8A	30,400	NF1600X-3P8A	38,000
2000	NF20001-3P8A	23,000	NF20003-3P8A	25,000	NF20004-3P8A	35,200	NF2000X-3P8A	44,000		
3150 ①	NF31501-3P8A	28,000	NF31503-3P8A	30,000	NF31504-3P8A	39,200	NF3150X-3P8A	49,000		

NOTE: All enclosed switches are provided with a black handle; however, most handles can be substituted with a red and yellow handle if desired. Please substitute the handle suffix code (2nd and 3rd from last characters) with the red/yellow handle catalog number suffix from page 18.130. There is no additional price adder for changing to a red/yellow handle of equal ratings and style.

EXAMPLE: A red/yellow selector handle for an NF161-3PB6A can be substituted for the black selector handle by using the "YJ" suffix instead of the "BJ" suffix, new catalog #NF161-3PYJA.

① IEC rated only.  
② New Washdown.

# 3 pole 16A – 3150A

Disconnect  
switches  
Non-fusible  
Enclosed



NF25P-3PY6A

## 3 Pole, 600V, 16A – 80A Selector handle

		NEMA Enclosure type					
		12 Plastic		12		7 & 9	
UL general purpose amp rating		Catalog number	List price	Catalog number	List price	Catalog number	List price
UL 508	16	NF16P-3PBJA	\$ 295	NF162-3PBJC	\$ 259	—	—
	16, oversize	—	—	—	—	—	—
	25	NF25P-3PBJA	300	NF252-3PBJC	264	—	—
	25, oversize	—	—	—	—	—	—
	40	NF32P-3PBJA	315	NF322-3PBJC	279	—	—
	40, oversize	—	—	—	—	—	—
	60	NF45P-3PBJB	350	NF452-3PBJB	320	—	—
	80	NF63P-3PBJA	380	NF632-3PBJA	354	—	—

## 3 Pole, 600V, 16A – 3150A Pistol handle

		NEMA Enclosure type					
		4X Plastic		12		7 & 9	
UL general purpose amp rating		Catalog number	List price	Catalog number	List price	Catalog number	List price
UL 508	16	NF16P-3PB6A	\$ 345	NF162-3PB6C	\$ 309	NF167-3P	\$ 1900
	25	NF25P-3PB6A	350	NF252-3PB6C	314	NF257-3P	1925
	40	NF32P-3PB6A	365	NF322-3PB6C	329	NF327-3P	1950
	60	NF45P-3PB6B	400	NF452-3PB6B	370	NF457-3P	3600
	80	NF63P-3PB6A	430	NF632-3PB6A	400	NF637-3P	3630
UL 98	30	NF30P-3PB6B	875	NF302-3PB6B	780	NF307-3P	4150
	60	NF60P-3PB6B	925	NF602-3PB6B	830	NF607-3P	4200
	100	NF100P-3PB6B	975	NF1002-3PB6B	880	NF1007-3P	4250
	125	NF125P-3PB8A	3000	NF1252-3PB6A	1400	—	—
	200	NF200P-3PB8B	4000	NF2002-3PB8B	1600	—	—
	400	NF400P-3PB4B	6000	NF4002-3PB4B	2900	—	—
	600	NF600P-3PB7B	10,000	NF6002-3PB7B	5100	—	—
	800	NF800P-3PB4A	16,000	NF8002-3PB4A	8400	—	—
	1200	NF1200P-3PB4A	19,000	NF12002-3PB4A	10,400	—	—
	1600	NF1600P-3P8A	31,000	NF16002-3P8A	19,400	—	—
	2000	NF2000P-3P8A	37,000	NF20002-3P8A	23,400	—	—
3150 <sup>②</sup>	NF3150P-3P8A	42,000	NF31502-3P8A	28,400	—	—	

① Please consult factory for pricing and availability  
② IEC rated only.

**Disconnect  
switches**  
Non-fusible  
Enclosed

## Switch & handle ratings 16A – 3150A

### Switch ratings, 16 – 3150 Amps, 600V

UL General purpose amp rating	Maximum horsepower rating							Wire size for terminal lugs	For wire type	Approval	
	Single phase			Three phase							
	120V	200V	240V	200V – 208V	240V	480V	600V				
UL 508	16	1	2	2	3	5	10	10	#18 – 8	Cu	CSA, UL
	25	1.5	3	3	7.5	7.5	15	20	#18 – 8	Cu	CSA, UL
	40	2	5	5	10	10	20	25	#18 – 8	Cu	CSA, UL
	60	2	5	5	15	15	30	30	#14 – 1	Cu	CSA, UL
	80	2	5	5	20	20	40	40	#14 – 1	Cu	CSA, UL
UL 98	30	2	5	5	10	10	20	30	#14 – 4	Cu	CSA, UL
	60	3	7.5	7.5	20	20	40	40	#14 – 4	Cu	CSA, UL
	100	5	15	15	25	30	50	50	#8 – 1/0	Cu	CSA, UL
	125	7.5	20	20	30	30	75	100	#8 – 1/0	Cu	CSA, UL
	200	—	—	—	60	75	150	200	#6 – 300 kcmil	Cu	CSA, UL
	400	—	—	—	100	125	250	350	#2 – 600 kcmil	Cu	CSA, UL
	600	—	—	—	150	200	400	500	(2) #2 – 600 kcmil	Cu	CSA, UL
	800	—	—	—	200	250	500	600	(2) #2 – 600 kcmil	Cu/Al	CSA, UL
	1200	—	—	—	—	—	—	—	(4) #2 – 600 kcmil	Cu/Al	CSA, UL
	1600	—	—	—	—	—	—	—	(4) #2 – 600 kcmil	Cu/Al	CSA, UL
2000	—	—	—	—	—	—	—	(8) #2 – 600 kcmil	Cu/Al	CSA, UL	
3150 ①	—	—	—	—	—	—	—	(8) #2 – 600 kcmil	Cu/Al	IEC	

### Handle ratings, 16 – 3150 Amps, 600V

Amperage range	Style type	NEMA	Color	Marking	Defeatable	Padlockable	Catalog number suffix	Catalog number
16 – 100	Selector	1,3R,12	Black	O/I & OFF/ON	Yes	Yes	BJ	OHB2AJ
	Selector	1,3R,12	Red/Yel					OHY2AJ
	Pistol	1,3R,12	Black					OHB65J5
	Pistol	1,3R,12	Red/Yel					OHY65J5
	Pistol	1,3R,4,4X,12	Black					OHB65L5
125 – 200	Pistol	1,3R,12	Black	O/I & OFF/ON	Yes	Yes	B6	OHB65J6
		1,3R,12	Red/Yel				Y6	OHY65J6
		1,3R,4,4X,12	Black				B8	OHB80L6
		1,3R,4,4X,12	Red/Yel				Y8	OHY80L6
400 – 3150	Pistol	1,3R,12	Black	O/I & OFF/ON	Yes	Yes	B4	OHB145J12
		1,3R,12	Red/Yel				Y4	OHY145J12
		1,3R,12	Black				B7	OHB175J12
		1,3R,12	Red/Yel				Y7	OHY175J12
		1,3R,4,4X,12	Black				B4	OHB145L12
		1,3R,4,4X,12	Red/Yel				Y4	OHY145L12
		1,3R,4,4X,12	Black				B7	OHB175L12
		1,3R,4,4X,12	Red/Yel				Y7	OHY175L12
1,3R,4,4X,12	Metal	8	YASDA-8					
16 – 200	Pistol	1,3R,12 1,3R,4,4X,12	Black	I/O/II	Yes	Yes	B8	OHB80J6E011 OHB80L6E011
400	Pistol	1,3R,12 1,3R,4,4X,12	Black	I/O/II	Yes	Yes	B4	OHB145J12E011 OHB145L12E011
400 – 3150	Pistol	1,3R,12	Black	I/O/II	Yes	Yes	B7	OHB175J12E011
	Pistol	1,3R,4,4X,12	Black				B7	OHB175L12E011
	Metallic	1,3R,4,4X,12	Metal				21	YASDA-21
	Metallic	1,3R,4,4X,12	Metal				6	YASDA-6

① IEC rated only.

## 2 pole 125A – 3150A

**Disconnect  
switches  
Non-fusible  
Enclosed**

### 2 Pole, 600V, 125A – 3150A

UL general purpose amp rating		NEMA Enclosure type							
		1		3R		4		4X Stainless	
		Catalog number	List price	Catalog number	List price	Catalog number	List price	Catalog number	List price
	125	NF1251-2PB6A	\$ 825	NF1253-2PB6A	\$ 1050	NF1254-2PB8A	\$ 2100	NF125X-2PB8A	\$ 2625
	200	NF2001-2PB8C	1170	NF2003-2PB8C	1485	NF2004-2PB8C	3170	NF200X-2PB8C	3960
	400	NF4001-2PB4C	2340	NF4003-2PB4C	2520	NF4004-2PB4C	5750	NF400X-2PB4C	7200
	600	NF6001-2PB7B	4320	NF6003-2PB7B	4500	NF6004-2PB7B	8640	NF600X-2PB7B	10,800
	800	NF8001-2PB4A	7200	NF8003-2PB4A	8460	NF8004-2PB4A	13,680	NF800X-2PB4A	17,100
	1200	NF12001-2PB4A	9000	NF12003-2PB4A	10,620	NF12004-2PB4A	16,200	NF1200X-2PB4A	20,250
	1600	NF16001-2P8A	17,100	NF16003-2P8A	18,720	NF16004-2P8A	27,360	NF1600X-2P8A	34,200
	2000	NF20001-2P8A	20,700	NF20003-2P8A	22,500	NF20004-2P8A	31,680	NF2000X-2P8A	39,600
	3150	NF31501-2P8A	25,200	NF31503-2P8A	27,000	NF31504-2P8A	35,280	N3150X-2P8A	44,100

### 2 Pole, 600V, 125A – 3150A

UL general purpose amp rating		NEMA Enclosure type			
		4X Plastic		12	
		Catalog number	List price	Catalog number	List price
	125	NF125P-2PB8A	\$ 2250	NF1252-2PB6A	\$ 1050
	200	NF200P-2PB8C	3600	NF2002-2PB8C	1440
	400	NF400P-2PB4C	5400	NF4002-2PB4C	2610
	600	NF600P-2PB7B	9000	NF6002-2PB7B	4590
	800	NF800P-2PB4A	14,400	NF8002-2PB4A	7560
	1200	NF1200P-2PB4A	17,100	NF12002-2PB4A	9360
	1600	NF1600P-2P8A	28,000	NF16002-2P8A	17,460
	2000	NF2000P-2P8A	33,300	NF20002-2P8A	21,060
	3150 ①	NF3150P-2P8A	37,800	NF31502-2P8A	25,560

16A – 100A switches are not available in 2 pole versions, use 3 pole.

① IEC rated only.

**Disconnect  
switches  
Non-fusible  
Enclosed**

# 4 pole 16A – 3150A

## 4 Pole, 600V, 16A – 3150A

UL general purpose amp rating		NEMA Enclosure type								
		1		3R		4		4X Stainless		
		Catalog number	List price	Catalog number	List price	Catalog number	List price	Catalog number	List price	
UL508		16	NF161-4PB6C	\$ 295	NF163-4PB6C	\$ 369	NF164-4PB6A	\$ 530	NF16X-4PB6C	\$ 665
		25	NF251-4PB6C	300	NF253-4PB6C	374	NF254-4PB6A	535	NF25X-4PB6C	670
		40	NF321-4PB6C	310	NF323-4PB6C	384	NF324-4PB6A	545	NF32X-4PB6C	680
		60	NF451-4PB6B	360	NF453-4PB6B	434	NF454-4PB6B	570	NF45X-4PB6B	700
		80	NF631-4PB6A	410	NF633-4PB6A	484	NF634-4PB6A	595	NF63X-4PB6A	740
UL98		30	NF301-4PB6B	650	NF303-4PB6B	988	NF304-4PB6B	1200	NF30X-4PB6B	1525
		60	NF601-4PB6B	700	NF603-4PB6B	1038	NF604-4PB6B	1250	NF60X-4PB6B	1575
		100	NF1001-4PB6B	750	NF1003-4PB6B	1088	NF1004-4PB6B	1300	NF100X-4PB6B	1625
		125	NF1251-4PB6A	1375	NF1253-4PB6A	1675	NF1254-4PB6A	3500	NF125X-4PB8A	4375
		200	NF2001-4PB8B	1625	NF2003-4PB8B	2063	NF2004-4PB8B	4400	NF200X-4PB8B	5500
		400	NF4001-4PB4B	3250	NF4003-4PB4B	3500	NF4004-4PB4B	8000	NF400X-4PB4B	10,000
		600	NF6001-4PB7B	6000	NF6003-4PB7B	6250	NF6004-4PB7B	12,000	NF600X-4PB7B	15,000
		800	NF8001-4PB4A	10,000	NF8003-4PB4A	11,750	NF8004-4PB4A	19,000	NF800X-4PB4A	23,750
		1200	NF12001-4PB4A	12,500	NF12003-4PB4A	14,750	NF12004-4PB4A	22,500	NF1200X-4PB4A	28,125
		1600	NF16001-4P8A	23,750	NF16003-4P8A	26,000	NF16004-4P8A	38,800	NF1600X-4P8A	47,500
		2000	NF20001-4P8A	28,750	NF20003-4P8A	31,250	NF20004-4P8A	44,000	NF2000X-4P8A	55,000
3150 ①	NF31501-4P8A	35,000	NF31503-4P8A	37,500	NF31504-4P8A	49,000	NF3150X-4P8A	61,250		

## 4 Pole, 600V, 16A – 3150A

UL general purpose amp rating		NEMA Enclosure type						
		4X Plastic		12		7 & 9		
		Catalog number	List price	Catalog number	List price	Catalog number	List price	
UL508		16	NF16P-4PB6A	\$ 405	NF162-4PB6C	\$ 369	NF167-4P	\$ 2025
		25	NF25P-4PB6A	410	NF252-4PB6C	374	NF257-4P	2050
		40	NF32P-4PB6A	420	NF322-4PB6C	384	NF327-4P	2075
		60	NF45P-4PB6B	465	NF452-4PB6B	434	NF457-4P	3700
		80	NF63P-4PB6A	510	NF632-4PB6A	484	NF637-4P	3730
UL_98		30	NF30P-4PB6B	1100	NF302-4PB6B	925	NF307-4P	4300
		60	NF60P-4PB6B	1150	NF602-4PB6B	975	NF607-4P	4350
		100	NF100P-4PB6B	1200	NF1002-4PB6B	1025	NF1007-4P	4400
		125	NF125P-4PB8A	3750	NF1252-4PB6A	1750	—	—
		200	NF200P-4PB8B	5000	NF2002-4PB8B	2000	—	—
		400	NF400P-4PB4B	7500	NF4002-4PB4B	3625	—	—
		600	NF600P-4PB7B	12,500	NF6002-4PB7B	6375	—	—
		800	NF800P-4PB4A	20,000	NF8002-4PB4A	10,500	—	—
		1200	NF1200P-4PB4A	23,750	NF12002-4PB4A	13,000	—	—
		1600	NF1600P-4P8A	38,500	NF16002-4P8A	24,250	—	—
		2000	NF2000P-4P8A	46,250	NF20002-4P8A	29,240	—	—
3150 ①	NF3150P-4P8A	52,500	NF31502-4P8A	35,500	—	—		



① IEC rated only.

# 6 pole 16A – 1200A

Disconnect  
switches  
Non-fusible  
Enclosed



## 6 Pole, 600V, 16A – 1200A

NEMA Enclosure type

UL general purpose amp rating	1		3R		4		4X Stainless		
	Catalog number	List price	Catalog number	List price	Catalog number	List price	Catalog number	List price	
UL508 	16	NF161-6PB6C	\$ 580	NF163-6PB6C	\$ 728	NF164-6PB6A	\$ 1080	NF16X-6PB6C	\$ 1350
	25	NF251-6PB6C	590	NF253-6PB6C	738	NF254-6PB6A	1090	NF25X-6PB6C	1360
	40	NF321-6PB6C	610	NF323-6PB6C	758	NF324-6PB6A	1110	NF32X-6PB6C	1380
UL98 	60	NF451-6PB6B	690	NF453-6PB6B	838	NF454-6PB6B	1140	NF45X-6PB6B	1430
	80	NF631-6PB6A	770	NF633-6PB6A	918	NF634-6PB6A	1185	NF63X-6PB6A	1480
	30	NF301-6PB6B	1230	NF303-6PB6B	1770	NF304-6PB6B	2110	NF30X-6PB6B	2660
	60	NF601-6PB6B	1280	NF603-6PB6B	1820	NF604-6PB6B	2160	NF60X-6PB6B	2710
	100	NF1001-6PB6B	1330	NF1003-6PB6B	1870	NF1004-6PB6B	2210	NF100X-6PB6B	2760
	125	NF1251-6PB2A	2200	NF1253-6PB2A	2800	NF1254-6PB4A	5600	NF125X-6PB4A	7000
	200	NF2001-6PB4B	2950	NF2003-6PB4B	3650	NF2004-6PB4B	7320	NF200X-6PB4B	9150
	400	NF4001-6P8B	5860	NF4003-6P8B	5960	NF4004-6P8B	13,090	NF400X-6P8B	16,360
	600	NF6001-6P8B	9960	NF6003-6P8B	10,360	NF6004-6P8B	19,490	NF600X-6P8B	24,360
	800	NF8001-6P8A	16,360	NF8003-6PB4A	19,800	NF8004-6P8A	30,690	NF800X-6P8A	38,360
1200	NF12001-6P8A	20,360	NF12003-6PB4A	23,960	NF12004-6P8A	36,290	NF1200X-6P8A	45,360	

## 6 Pole, 600V, 16A – 1200A

NEMA Enclosure type

UL general purpose amp rating	4X Plastic		12		7 & 9		IP65 Plastic		
	Catalog number	List price	Catalog number	List price	Catalog number	List price	Catalog number	List price	
UL508 	16	NF16P-6PB6A	\$ 800	NF162-6PB6C	\$ 728	NF167-6P	\$ 3750	NF16E-6PB6B	\$ 410
	25	NF25P-6PB6A	810	NF252-6PB6C	738	NF257-6P	3775	NF25E-6PB6B	420
	40	NF32P-6PB6A	830	NF322-6PB6C	758	NF327-6P	3800	NF32E-6PB6B	450
UL 98 	60	NF45P-6PB6B	930	NF452-6PB6B	838	NF457-6P	4275	NF45E-6PB6B	520
	80	NF63P-6PB6A	1030	NF632-6PB6A	918	NF637-6P	4325	NF63E-6PB6B	770
	30	NF30P-6PB6B	1900	NF302-6PB6B	1670	—	—	NF30E-6PB6B	1230
	60	NF60P-6PB6B	1950	NF602-6PB6B	1720	—	—	NF60E-6PB6B	1280
	100	NF100P-6PB6B	2000	NF1002-6PB6B	1770	—	—	NF100E-6PB6B	1330
	125	NF125P-6PB4A	6000	NF1252-6PB4A	2800	—	—	—	—
	200	NF200P-6PB4B	8350	NF2002-6PB4B	3550	—	—	—	—
	400	NF400P-6P8B	12,360	NF4002-6P8B	6160	—	—	—	—
	600	NF600P-6P8B	20,360	NF6002-6P8B	10,560	—	—	—	—
	800	NF800P-6P8A	32,360	NF8002-6P8A	17,800	—	—	—	—
1200	NF1200P-6P8A	38,360	NF12002-6P8A	21,800	—	—	—	—	

⊙ ≡ = Three poles

**Disconnect  
switches**  
Non-fusible  
Enclosed

## 3 pole transfer switches 16A – 1200A

### 3 Pole, 600V, 16A – 1200A

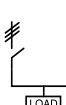
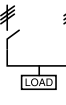
UL general purpose amp rating		NEMA Enclosure type							
		1		3R		4		4X Stainless	
		Catalog number	List price	Catalog number	List price	Catalog number	List price	Catalog number	List price
UL508 	16	NF161-3TB8C	\$ 760	NF163-3TB8C	\$ 908	NF164-3TB8C	\$ 1200	NF16X-3TB8C	\$ 1850
	25	NF251-3TB8C	770	NF253-3TB8C	918	NF254-3TB8C	1230	NF25X-3TB8C	1880
	40	NF321-3TB8C	790	NF323-3TB8C	954	NF324-3TB8C	1260	NF32X-3TB8C	1950
UL98 	60	NF451-3TB8B	870	NF453-3TB8B	1018	NF454-3TB8B	1340	NF45X-3TB8B	3500
	80	NF631-3TB8A	950	NF633-3TB8A	1098	NF634-3TB8A	1420	NF63X-3TB8A	3600
	30	NF301-3TB8B	1410	NF303-3TB8B	1830	NF304-3TB8B	2400	NF30X-3TB8B	3900
	60	NF601-3TB8B	1460	NF603-3TB8B	1880	NF604-3TB8B	2450	NF60X-3TB8B	3950
	100	NF1001-3TB8B	1510	NF1003-3TB8B	1930	NF1004-3TB8B	2500	NF100X-3TB8B	4000
	125	NF1251-3TB8A	2380	NF1253-3TB8A	2980	NF1254-3TB8A	3500	NF125X-3TB8A	5000
	200	NF2001-3TB4B	3150	NF2003-3TB4B	3850	NF2004-3TB4B	7480	NF200X-3TB4B	9350
	400	NF4001-3TB4B	5960	NF4003-3TB4B	6160	NF4004-3TB4B	13,250	NF400X-3TB4B	16,560
	600	NF6001-3TB4A	10,260	NF6003-3TB4A	10,660	NF6004-3TB4A	19,730	NF600X-3TB4A	24,660
	800	NF8001-3TB4A	16,660	NF8003-3TB4A	19,460	NF8004-3TB4A	30,920	NF800X-3TB4A	38,660
	1200	NF12001-3TB4A	20,660	NF12003-3TB4A	24,260	NF12004-3TB4A	36,530	NF1200X-3TB4A	45,660

### 3 Pole, 600V, 16A – 1200A

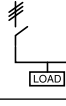
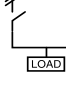
UL general purpose amp rating		NEMA Enclosure type			
		4X Plastic		12	
		Catalog number	List price	Catalog number	List price
UL508 	16	NF16P-3TB8A	\$ 1000	NF162-3TB8C	\$ 908
	25	NF25P-3TB8A	1040	NF252-3TB8C	918
	40	NF32P-3TB8A	1100	NF322-3TB8C	938
UL98 	60	NF45P-3TB8B	1180	NF452-3TB8B	1018
	80	NF63P-3TB8A	1260	NF632-3TB8A	1098
	30	NF30P-3TB8B	2000	NF302-3TB8B	1730
	60	NF60P-3TB8B	2050	NF602-3TB8B	1830
	100	NF100P-3TB8B	2100	NF1002-3TB8B	1930
	125	NF125P-3TB8A	3200	NF1252-3TB8A	2980
	200	NF200P-3TB4B	8550	NF2002-3TB4B	3750
	400	NF400P-3TB4B	12,560	NF4002-3TB4B	6460
	600	NF600P-3TB4A	20,660	NF6002-3TB4A	10,760
	800	NF800P-3TB4A	32,660	NF8002-3TB4A	17,460
	1200	NF1200P-3TB4A	38,660	NF12002-3TB4A	21,460

# 3 pole bypass switches 16A – 1200A

Disconnect  
switches  
Non-fusible  
Enclosed

## 3 Pole, 600V, 16A – 1200A

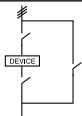
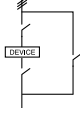
		NEMA Enclosure type								
		1		3R		4		4X Stainless		
UL general purpose amp rating		Catalog number	List price	Catalog number	List price	Catalog number	List price	Catalog number	List price	
UL508		16	NF161-3BB8A	\$ 1045	NF163-3BB8A	\$ 1267	NF164-3BB8A	\$ 1480	NF16X-3BB8A	\$ 3740
		25	NF251-3BB8A	1060	NF253-3BB8A	1282	NF254-3BB8A	1540	NF25X-3BB8A	3820
		40	NF321-3BB8A	1090	NF323-3BB8A	1297	NF324-3BB8A	1600	NF32X-3BB8A	3900
		60	NF451-3BB8B	1215	NF453-3BB8B	1312	NF454-3BB8B	1750	NF45X-3BB8B	4050
		80	NF631-3BB8A	1340	NF633-3BB8A	1432	NF634-3BB8A	1850	NF63X-3BB8A	4150
UL98		30	NF301-3BB8B	1970	NF303-3BB8B	2300	NF304-3BB8B	2800	NF30X-3BB8B	4800
		60	NF601-3BB8B	2070	NF603-3BB8B	2400	NF604-3BB8B	2900	NF60X-3BB8B	4900
		100	NF1001-3BB8B	2170	NF1003-3BB8B	2500	NF1004-3BB8B	3000	NF100X-3BB8B	5000
		125	—	—	—	—	—	—	—	—
		200	—	—	—	—	—	—	—	—
		400	NF4001-3B6B	8460	NF4003-3B6B	9060	NF4004-3B6B	19,750	NF400X-3B6B	24,660
		600	NF6001-3B6B	15,060	NF6003-3B6B	15,660	NF6004-3B6B	29,330	NF600X-3B6B	36,660
		800	NF8001-3B6A	24,660	NF8003-3B6A	28,860	NF8004-3B6A	46,130	NF800X-3B6A	57,660
		1200	NF12001-3B6A	30,660	NF12003-3B6A	36,060	NF12004-3B6A	55,040	NF1200X-3B6A	68,800

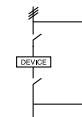
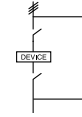

## 3 Pole, 600V, 16A – 1200A

		NEMA Enclosure type				
		4X Plastic		12		
UL general purpose amp rating		Catalog number	List price	Catalog number	List price	
UL508		16	NF16P-3BB8A	\$ 1300	NF162-3BB8A	\$ 1267
		25	NF25P-3BB8A	1325	NF252-3BB8A	1282
		40	NF32P-3BB8A	1350	NF322-3BB8A	1297
		60	NF45P-3BB8B	1420	NF452-3BB8B	1312
		80	NF63P-3BB8A	1550	NF632-3BB8A	1432
UL98		30	NF30P-3BB8B	2400	NF302-3BB8B	2300
		60	NF60P-3BB8B	2500	NF602-3BB8B	2400
		100	NF100P-3BB8B	2600	NF1002-3BB8B	2500
		125	—	—	—	—
		200	—	—	—	—
		400	NF400P-3B6B	18,660	NF4002-3B6B	9360
		600	NF600P-3B6B	30,660	NF6002-3B6B	15,960
		800	NF800P-3B6A	48,660	NF8002-3B6A	25,860
		1200	NF1200P-3B6A	57,660	NF12002-3B6A	31,860



**Disconnect  
switches**  
Non-fusible  
Enclosed

## 3 pole mechanically interlocked switches 16A – 1200A

### 3 Pole, 600V, 16A – 1200A

		NEMA Enclosure type								
		1		3R		4		4X Stainless		
UL general purpose amp rating		Catalog number	List price	Catalog number	List price	Catalog number	List price	Catalog number	List price	
UL508		16	NF161-3MB6A	\$ 640	NF163-3MB6A	\$ 788	NF164-3MB6A	\$ 1120	NF16X-3MB6A	\$ 1410
		25	NF251-3MB6A	650	NF253-3MB6A	798	NF254-3MB6A	1160	NF25X-3MB6A	1420
		40	NF321-3MB6A	670	NF323-3MB6A	818	NF324-3MB6A	1170	NF32X-3MB6A	1440
UL98		60	NF451-3MB6B	750	NF453-3MB6B	908	NF454-3MB6B	1200	NF45X-3MB6B	1490
		80	NF631-3MB6A	830	NF633-3MB6A	978	NF634-3MB6A	1245	NF63X-3MB6A	1540
		30	NF301-3MB6B	1290	NF303-3MB6B	1830	NF304-3MB6B	2170	NF30X-3MB6B	2700
		60	NF601-3MB6B	1340	NF603-3MB6B	1880	NF604-3MB6B	2210	NF60X-3MB6B	2770
		100	NF1001-3MB6B	1390	NF1003-3MB6B	1930	NF1004-3MB6B	2270	NF100X-3MB6B	2800
		125	NF1251-3MB6A	2260	NF1253-3MB6A	2860	NF1254-3MB8A	5660	NF125X-3MB8A	7060
		200	NF2001-3MB8B	3010	NF2003-3MB8B	3710	NF2004-3MB8B	7380	NF200X-3MB8B	9210
		400	NF4001-3MB4B	5920	NF4003-3MB4B	6030	NF4004-3MB4B	13,150	NF400X-3MB4B	16,420
		600	NF6001-3MB7B	10,020	NF6003-3MB7B	10,420	NF6004-3MB7B	19,550	NF600X-3MB7B	24,420
		800	NF8001-3MB4A	16,420	NF8003-3MB4A	19,860	NF8004-3MB4A	30,750	NF800X-3MB4A	38,420
1200	NF12001-3MB4A	20,420	NF12003-3MB4A	24,020	NF12004-3MB4A	36,350	NF1200X-3MB4A	45,420		

### 3 Pole, 600V, 16A – 1200A

		NEMA Enclosure type				
		4X Plastic		12		
UL general purpose amp rating		Catalog number	List price	Catalog number	List price	
UL508		16	NF16P-3MB6A	\$ 860	NF162-3MB6A	\$ 788
		25	NF25P-3MB6A	870	NF252-3MB6A	798
		40	NF32P-3MB6A	890	NF322-3MB6A	818
UL98		60	NF45P-3MB6B	990	NF452-3MB6B	908
		80	NF63P-3MB6A	1090	NF632-3MB6A	978
		30	NF30P-3MB6B	1900	NF302-3MB6B	1830
		60	NF60P-3MB6B	1950	NF602-3MB6B	1880
		100	NF100P-3MB6B	2000	NF1002-3MB6B	1930
		125	NF125P-3MB8A	6000	NF1252-6PB6A	2860
		200	NF200P-3MB8B	8350	NF2002-3MB8B	3710
		400	NF400P-3MB4B	12,360	NF4002-3MB4B	6030
		600	NF600P-3MB7B	20,360	NF6002-3MB7B	10,420
		800	NF800P-3MB4A	32,360	NF8002-3MB4A	19,860
1200	NF1200P-3MB4A	38,360	NF12002-3MB4A	24,020		

## Accessories ①

Disconnect  
switches  
Non-fusible  
Enclosed

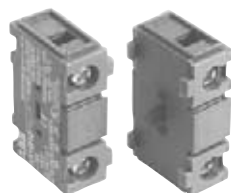

OA1G\_

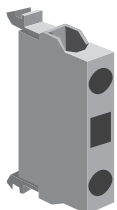

OBEA\_

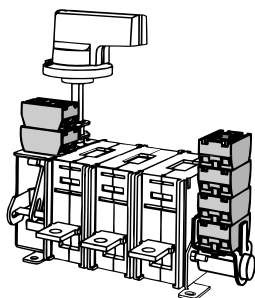

OZ XK\_



3 Position selector switch



Pilot light

### Auxiliary contacts

For use on:	Contact configuration	Catalog number	Installation suffix	Installed list price adder
16A – 100A	1 N.O.	OA1G10	add "10" suffix	\$ 30
	1 N.C.	OA1G01	add "01" suffix	30
	1 N.O. & 1 N.C.	OA1G11	add "11" suffix	60
125A	1 N.O.	OBEA10	add "10" suffix	50
	1 N.C.	OBEA01	add "01" suffix	50
200A – 600A	1 N.O.	OA1G10	add "10" suffix	50
	1 N.C.	OA3G01	add "01" suffix	50
800A – 3150A	1 N.O. & 1 N.C.	OZ XK-1	add "11" suffix	130
	2 N.O. & 2 N.C.	OZ XK-2	add "22" suffix	200

### Accessories ①

For use on:	Description	Installation suffix	Installed list price adder
OT16, 25,32 OT45, 63 OT30, 60, 100 OT160 200A – 1200A 1600A – 3150A	Neutral or isolated ground block	N or G	\$ 30
	Neutral or isolated ground block	N or G	54
	Neutral or isolated ground block	N or G	75
	Neutral or isolated ground block	N or G	150
	Neutral block	N	210
30A – 1200A 30A – 1200A	Service entrance, 3 wire	U	100
	Service entrance, 4 wire	V	200
16A – 3150A	Start/stop pushbuttons	A	68
	2 position selector switch	C	68
	3 position selector switch	D	78
	Pilot light "red/run"	E	110
	Ammeter 1 phase ②	AM	940
	Voltmeter ②	VM	2300

① Please consult factory for special customer requirements.

② Current transformers included.

## Technical data

### Other configuration descriptions

#### Conversion mechanisms

##### 6 or 8 pole

6 (8) pole mechanism allows two switches controlled by one handle to open or close simultaneously.

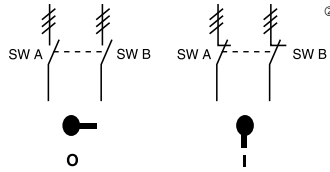

	POS. O	POS. I
SW. A	O	X
SW. B	O	X

X = Closed  
O = Open

##### Transfer<sup>①</sup>

Transfer mechanism manually transfers between two power sources using two switches and a center "OFF" position.

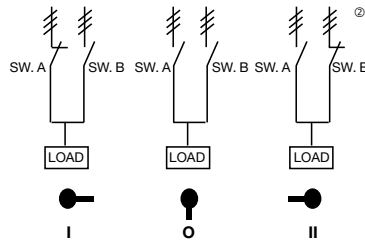

	POS. I	POS.O	POS.II
SW. A	X	O	O
SW. B	O	O	X

X = Closed  
O = Open

##### Bypass<sup>①</sup>

Bypass mechanism operates three switches: Two switches in series and one changeover switch to allow power bypass.

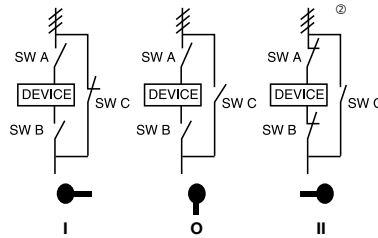

	POS. I	POS.O	POS.II
SW. A	O	O	X
SW. B	O	O	X
SW. C	X	O	O

X = Closed  
O = Open

##### Mechanical interlock

Mechanical interlock mechanism prevents both switches from being in the ON position at the same time.

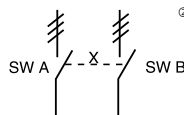

	SW. A POS. I	SW. B POS. O
SW. A	X	O
SW. B	O	X

X = Closed  
O = Open

① Transfer and bypass enclosed switches include the load side bussed or cabled together, and all switches come standard with ground lugs.

② = Three poles

# Approximate dimensions

## 2, 3 & 4 Pole ③

### 16A – 3150A, non-fusible

Disconnect  
switches  
Non-fusible  
Enclosed

#### Non-Fusible

Frame size	Enclosure type	H height	W width	D depth	MH mtg. height	MW mtg. width	Weight
OT16_ OT25_ OT32_	1	7.0	5.0	3.0	4.0	4.0	4.0
	3R	7.0	5.0	3.0	7.75	3.0	4.0
	4	6.0	6.0	4.0	6.75	4.0	4.0
	4X SS	7.0	5.0	3.0	7.75	3.0	4.0
	4X Plastic	6.0	6.0	5.9	6.75	4.0	4.0
	12	7.0	5.0	3.0	7.75	3.0	4.0
	IP65 (A)	4.8	3.4	2.4	4.17	2.80	1.0
IP65 (B)	5.9	5.1	2.4	5.35	4.57	1.0	
OT45_ OT63_ OT30_ OT60_	1	8.0	6.0	4.0	7.0	5.0	6.0
	3R	8.0	6.0	4.0	8.75	4.0	6.0
	4	8.0	6.0	4.0	8.75	4.0	6.0
	4X SS	8.0	6.0	4.0	8.75	4.0	6.0
	4X Plastic	8.0	6.0	5.9	8.75	4.0	6.0
	12	8.0	6.0	4.0	8.75	4.0	6.0
	IP65 (A)	7.9	5.7	3.6	7.24	5.16	4.0
IP65 (B)	15.8	7.9	5.5	14.8	6.93	4.0	
OT100	1	10.0	8.0	5.0	7.0	7.0	9.0
	3R	10.0	8.0	5.0	10.75	6.0	9.0
	4	10.0	8.0	5.0	10.75	6.0	9.0
	4X SS	10.0	8.0	5.0	10.75	6.0	9.0
	4X Plastic	10.0	8.0	5.9	10.75	6.0	9.0
	12	10.0	8.0	5.0	10.75	6.0	9.0
	IP65 (A)	7.9	5.7	3.6	7.24	5.16	4.0
IP65 (B)	15.8	7.9	5.5	14.8	6.93	4.0	
OT160	1	14.0	12.0	8.0	11.0	9.0	20
	3R	14.0	12.0	8.0	14.75	10.0	20
	4	14.0	12.0	8.0	14.75	10.0	20
	4X SS	14.0	12.0	8.0	14.75	10.0	20
	4X Plastic	14.0	12.0	8.0	14.75	10.0	12
	12	14.0	12.0	8.0	14.75	10.0	20

Frame size	Enclosure type	H height	W width	D depth	mtg. height	MW mtg. width	Weight
OT200	1	20.0	16.0	6.0	25.5	14.5	50
	3R	20.0	16.0	6.0	25.5	14.5	50
	4	20.0	16.0	6.0	25.5	14.5	50
	4X SS	20.0	16.0	6.0	25.5	14.5	50
	4X Plastic	20.0	16.0	6.0	25.5	14.5	40
OT400	1	36.0	24.0	8.0	37.5	22.5	120
	3R	36.0	24.0	8.0	37.5	22.5	120
	4	①	①	①	①	①	①
	4X SS	36.0	24.0	8.0	37.5	22.5	130
	4X Plastic	①	①	①	①	①	①
OT600	1	36.0	24.0	8.0	37.5	22.5	120
	3R	36.0	24.0	12.0	37.5	22.5	120
	4	36.0	24.0	12.0	37.5	22.5	120
	4X SS	36.0	24.0	12.0	37.5	22.5	120
	4X Plastic	40.0	32.0	12.0	41.2	30.2	120
OETL-NF800A OETL-NF1200	1	36.0	24.0	12.0	37.5	22.5	120
	3R	36.0	24.0	12.0	37.5	22.5	120
	4	36.0	24.0	12.0	37.5	22.5	120
	4X SS	60.0	36.0	12.0	61.5	34.5	200
	4X Plastic	①	①	①	①	①	①
OETL-NF1600 OETL-NF2000 OETL-NF3150	1	60.0	36.0	12.0	61.5	34.5	200
	3R	60.0	36.0	12.0	61.5	34.5	200
	4	60.0	36.0	12.0	61.5	34.5	200
	4X SS	60.0	36.0	12.0	61.5	34.5	200
	4X Plastic	①	①	①	①	①	①
OETL-NF1600 OETL-NF2000 OETL-NF3150	1	90.0	36.0	24.0	②	②	600
	3R	90.0	36.0	24.0	②	②	600
	4	①	①	①	①	①	①
	4X SS	①	①	①	①	①	①
	4X Plastic	①	①	①	①	①	①
12	90.0	36.0	24.0	②	②	600	

- ① Please consult factory, enclosures are sized to suit specific customer needs.
- ② Enclosure is free standing.
- ③ Some 4-pole switches require larger enclosures. Please consult factory.

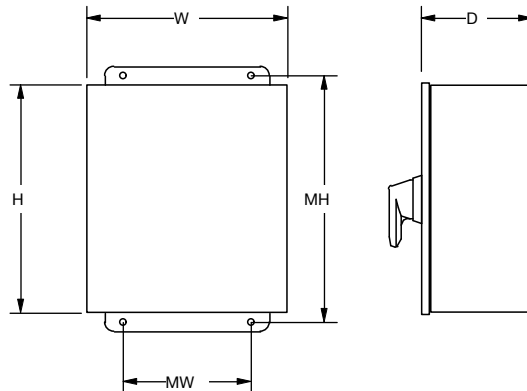

600V, 16A - 3150A  
2, 3 and 4-pole switches  
Enclosure dimensions

Disconnect  
switches  
Fusible  
Enclosed

## 3 Pole 30A – 800A



FJ30X-3PB6B

### 3 Pole<sup>®</sup>, 600V, 30A – 800A

NEMA Enclosure type

UL general purpose amp rating	Fuse type	NEMA Enclosure type								
		1		3R		4		4X Stainless		
		Catalog number	List price	Catalog number	List price	Catalog number	List price	Catalog number	List price	
	30	J	FJ301-3PB6B	\$ 560	FJ303-3PB6B	\$ 600	FJ304-3PB6B	\$ 1100	FJ30X-3PB6B	\$ 1400
	30	CC	FC301-3PB6B		FC303-3PB6B		FC304-3PB6B		FC30X-3PB6B	
	60	J <sup>®</sup>	FJ601-3PB6B	660	FJ603-3PB6B	860	FJ604-3PB8B	1300	FJ60X-3PB8B	1800
	100	J <sup>®</sup>	FJ1001-3PB8B	960	FJ1003-3PB8B	1140	FJ1004-3PB8B	2800	FJ100X-3PB8B	3800
	200	J <sup>®</sup>	FJ2001-3PB8C	2200	FJ2003-3PB8C	2400	FJ2004-3PB8C	3900	FJ200X-3PB8C	5000
	400	J <sup>®</sup>	FJ4001-3PB4C	3800	FJ4003-3PB4C	4200	FJ4004-3PB4C	7700	FJ400X-3PB4B	10,800
600	J <sup>®</sup>	FJ6001-3PB7C	5300	FJ6003-3PB7C	6800	FJ6004-3PB7C	11,000	FJ600X-3PB7C	16,000	
800	L	FL8001-3PB4B	9500	FL8003-3PB4B	11,200	FL8004-3PB4B	16,000	FL800X-3PB4B	21,000	

### 3 Pole<sup>®</sup>, 600V, 30A – 800A

NEMA Enclosure type

UL general purpose amp rating	Fuse type	NEMA Enclosure type				
		4X Plastic		12		
		Catalog number	List price	Catalog number	List price	
	30	J	FJ30P-3PB6B		FJ302-3PB6B	
	30	CC	FC30P-3PB6B	\$ 1040	FC302-3PB6B	\$ 600
	60	J <sup>®</sup>	FJ60P-3PB8B	1300	FJ602-3PB6B	860
	100	J <sup>®</sup>	FJ100P-3PB8B	2800	FJ1002-3PB8B	1140
	200	J <sup>®</sup>	FJ200P-3PB8C	4400	FJ2002-3PB8C	2400
	400	J <sup>®</sup>	FJ400P-3PB4C	8400	FJ4002-3PB4C	4200
600	J <sup>®</sup>	FJ600P-3PB7C	13,600	FJ6002-3PB7C	6200	
800	L	FL800P-3PB4B	17,400	FL8002-3PB4B	9800	

NOTE: All enclosed switches are provided with a black handle; however, most handles can be substituted with a red / yellow handle if desired. Please substitute the handle suffix code (2nd and 3rd from last characters) with the red/yellow handle catalog number suffix from page 18.130. There is no additional price adder for changing to a red/yellow handle of equal ratings and style.

18

EXAMPLE: A red/yellow pistol handle for an FJ301-3PB6B can be substituted for the black pistol handle by using the "Y6" suffix instead of the "B6" suffix, new catalog number: FJ301-3PY6B.

① Fusible switches are UL listed to the UL98 standard.

# Switch and handle ratings

## 30A – 800A

Disconnect  
switches  
Fusible  
Enclosed

### Switch ratings

UL general purpose amp rating	Maximum horsepower rating								Wire size for terminal lugs	For wire type	Approval ①
	Single phase			Three phase							
	120V	200V	240V	200V	208V	240V	480V	600V			
30	2	3	5	5	7.5	7.5	15	20	#18 – 8	Cu	CSA, UL
60	3	7.5	10	15	15	15	30	50	#14 – 4	Cu	CSA, UL
100	5	10	15	25	25	30	60	75	#14 – 2/0	Cu/Al	CSA, UL
200	—	—	—	50	50	60	125	150	#6 – 300 kcmil	Cu/Al	CSA, UL
400	—	—	—	100	125	125	250	350	#2 – 600 kcmil	Cu/Al	CSA, UL
600	—	—	—	150	150	200	400	500	(2) #2 – 600 kcmil	Cu/Al	CSA, UL
800	—	—	—	200	200	250	500	600	(2) #2 – 600 kcmil	Cu/Al	CSA, UL

### Handle ratings

Amperage range	Style type	NEMA	Color	Marking	Defeatable	Padlockable	Catalog number suffix	Catalog number
30	Selector	1,3R,12	Black	O/I & OFF/ON	Yes	Yes	BJ	OHB2AJ
	Selector	1,3R,12	Red/Yel				YJ	OHY2AJ
	Pistol	1,3R,12	Black				B6	OHB65J5
	Pistol	1,3R,12	Red/Yel				Y6	OHY65J5
	Pistol	1,3R,4,4X,12	Black				B6	OHB65L5
	Pistol	1,3R,4,4X,12	Red/Yel	Y6	OHY65L5			
60 – 200	Pistol	1,3R,12	Black	O/I & OFF/ON	Yes	Yes	B6	OHB65J6
		1,3R,12	Red/Yel				Y6	OHY65J6
		1,3R,12	Black				B8	OHB80J6
		1,3R,12	Red/Yel				Y8	OHB80J6
		1,3R,4,4X,12	Black				B8	OHB80L6
		1,3R,4,4X,12	Red/Yel	Y8	OHY80L6			
400 – 800	Pistol	1,3R,12	Black	O/I & OFF/ON	Yes	Yes	B4	OHB145J12
		1,3R,12	Red/Yel		Yes		Y4	OHY145J12
		1,3R,12	Black		Yes		B7	OHB175J12
		1,3R,12	Red/Yel		Yes		Y7	OHY175J12
		1,3R,4,4X,12	Black		Yes		B4	OHB145L12
		1,3R,4,4X,12	Red/Yel		Yes		Y4	OHY145L12
		1,3R,4,4X,12	Black		Yes		B7	OHB175L12
		1,3R,4,4X,12	Red/Yel		Yes		Y7	OHY175L12
		1,3R,4,4X,12	Metal	No	8	YASDA-8		
30	Pistol	1,3R,12	Black	I/O/II	Yes	Yes	B6	OHB65J6E011
		1,3R,4,4X,12					Y6	OHY65L6E011
60 – 200	Pistol	1,3R,12	Black	I/O/II	Yes	Yes	B8	OHB80J6E011
		1,3R,4,4X,12					Y8	OHY80L6E011
400 – 800	Pistol	1,3R,12	Black	I/O/II	Yes	Yes	B4	OHB145J12E011
	Pistol	1,3R,4,4X,12	Black		Yes		B4	OHB145L12E011
	Pistol	1,3R,12	Black		Yes		B7	OHB175J12E011
	Pistol	1,3R,4,4X,12	Black		Yes		B7	OHB175L12E011
	Metallic	1,3R,4,4X,12	Metal		No		21	YASDA-21
	Metallic	1,3R,4,4X,12	Metal		No		6	YASDA-6

① Fusible switches are UL listed to the UL98 standard.

Disconnect  
switches  
Fusible  
Enclosed

## 2 & 4 Pole 30A – 800A

### 2 Pole, 600V, 30A – 800A

		NEMA Enclosure type								
		1		3R		4		4X Stainless		
UL general purpose amp rating	Fuse type	Catalog number	List price	Catalog number	List price	Catalog number	List price	Catalog number	List price	
	30	J	—	—	—	—	—	—	—	
	30	CC	—	—	—	—	—	—	—	
	60	J	—	—	—	—	—	—	—	
	100	J	FJ1001-2PB8B	\$ 864	FJ1003-2PB8B	\$ 1026	FJ1004-2PB8B	\$ 2735	FJ100X-2PB8B	\$ 3420
	200	J	FJ2001-2PB8C	1980	FJ2003-2PB8C	2160	FJ2004-2PB8C	3600	FJ200X-2PB8C	4500
	400	J	FJ4001-2PB4C	3420	FJ4003-2PB4C	3780	FJ4004-2PB4C	7775	FJ400X-2PB4C	9720
	600	J	FJ6001-2PB7C	4770	FJ6003-2PB7C	6120	FJ6004-2PB7C	11,520	FJ600X-2PB7C	14,400
	800	L	FL8001-2PB4B	8550	FL8003-2PB4B	10,080	FL8004-2PB4B	15,120	FL800X-2PB4B	18,900

UL 98

### NEMA Enclosure type

		NEMA Enclosure type				
		4X Plastic		12		
UL general purpose amp rating	Fuse type	Catalog number	List price	Catalog number	List price	
	30	J	—	—	—	
	30	CC	—	—	—	
	60	J	—	—	—	
	100	J	FJ100P-2PB8B	\$ 2520	FJ1002-2PB8B	\$ 1026
	200	J	FJ200P-2PB8C	3960	FJ2002-2PB8C	2160
	400	J	FJ400P-2PB4C	7560	FJ4002-2PB4C	3780
	600	J	FJ600P-2PB7C	12,240	FJ6002-2PB7C	5580
	800	L	FL800P-2PB4B	15,660	FL8002-2PB4B	8820

UL 98

### 4 Pole, 600V, 30A – 800A

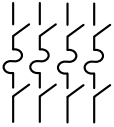
		NEMA Enclosure type								
		1		3R		4		4X Stainless		
UL general purpose amp rating	Fuse type	Catalog number	List price	Catalog number	List price	Catalog number	List price	Catalog number	List price	
	30	J	FJ301-4PB6B	\$ 700	FJ303-4PB6B	\$ 750	FJ304-4PB6B	\$ 1375	FJ30X-4PB6B	\$ 1750
	30	CC	FC301-4PB6B	—	FC303-4PB6B	—	FC304-4PB6B	—	FC30X-4PB6B	—
	60	J	FJ601-4PB6B	825	FJ603-4PB6B	1075	FJ604-4PB8B	1800	FJ60X-4PB8B	2250
	100	J	FJ1001-4PB8B	1200	FJ1003-4PB8B	1425	FJ1004-4PB8B	3800	FJ100X-4PB8B	4750
	200	J	FJ2001-4PB8C	2750	FJ2003-4PB8C	3000	FJ2004-4PB8C	5000	FJ200X-4PB8C	6250
	400	J	FJ4001-4PB4C	4750	FJ4003-4PB4C	5250	FJ4004-4PB4C	10,800	FJ400X-4PB4C	13,500
	600	J	FJ6001-4PB7C	6625	FJ6003-4PB7C	8500	FJ6004-4PB7C	16,000	FJ600X-4PB7C	20,000
	800	L	FL8001-4PB4B	11,875	FL8003-4PB4B	14,000	FL8004-4PB4B	21,000	FL800X-4PB4B	26,250

UL 98

### NEMA Enclosure type

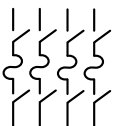
		NEMA Enclosure type				
		4X Plastic		12		
UL general purpose amp rating	Fuse type	Catalog number	List price	Catalog number	List price	
	30	J	FJ30P-4PB6B	\$ 1300	FJ302-4PB6B	\$ 750
	30	CC	FC30P-4PB6B	—	FC302-4PB6B	—
	60	J	FJ60P-4PB8B	1625	FJ602-4PB6B	1075
	100	J	FJ100P-4PB8B	3500	FJ1002-4PB8B	1425
	200	J	FJ200P-4PB8C	5500	FJ2002-4PB8C	3000
	400	J	FJ400P-4PB4C	10,500	FJ4002-4PB4C	5250
	600	J	FJ600P-4PB7C	17,000	FJ6002-4PB7C	7750
	800	L	FL800P-4PB4B	21,750	FL8002-4PB4B	12,250

UL 98

18

# 6 Pole & Mechanically interlocked switches 30A – 800A

Disconnect  
switches  
Fusible  
Enclosed

## 6 Pole, 600V, 30A – 800A

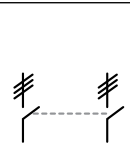
UL general purpose amp rating		Fuse type	NEMA Enclosure type							
			1		3R		4		4X Stainless	
			Catalog number	List price	Catalog number	List price	Catalog number	List price	Catalog number	List price
	30	J	FJ301-6PB6B	\$ 1300	FJ303-6PB6B	\$ 1400	FJ304-6PB6B	\$ 2150	FJ30X-6PB6B	\$ 3020
	30	CC	FC301-6PB6B		FC303-6PB6B		FC304-6PB6B		FC30X-6PB6B	
	60	J	FJ601-6PB4B	1450	FJ603-6PB4B	1600	FJ604-6PB4B	2450	FJ60X-6PB4B	3820
	100	J	FJ1001-6PB4B	2000	FJ1003-6PB4B	2200	FJ1004-6PB4B	3375	FJ100X-6PB4B	7820
	200	J	—	—	—	—	—	—	—	—
	400	J	FJ4001-6P8C	7350	FJ4003-6P8C	8050	FJ4004-6P8C	15,950	FJ400X-6P8C	22,160
	600	J	FJ6001-6P8C	10,050	FJ6003-6P8C	13,000	FJ6004-6P8C	23,450	FJ600X-6P8C	32,560
	800	L	FL8001-6P8B	17,600	FL8003-6P8B	20,600	FL8004-6P8B	30,650	FL800X-6P8B	42,560

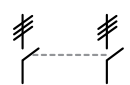
UL general purpose amp rating		Fuse type	NEMA Enclosure type			
			4X Plastic		12	
			Catalog number	List price	Catalog number	List price
	30	J	FJ30P-6PB6B	\$ 1575	FJ302-6PB6B	\$ 1480
	30	CC	FC30P-6PB6B		FC302-6PB6B	
	60	J	FJ60P-6PB4B	1820	FJ602-6PB4B	1850
	100	J	FJ100P-6PB4B	2475	FJ1002-6PB4B	2350
	200	J	—	—	—	—
	400	J	FJ400P-6PB8C	15,600	FJ4002-6PB8C	8050
	600	J	FJ600P-6P8C	25,000	FJ6002-6P8C	11,600
	800	L	FL800P-6P8B	31,800	FL8002-6P8B	18,750

## Mechanically interlocked, 600V, 30A – 800A

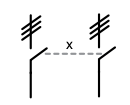
UL general purpose amp rating		Fuse type	NEMA Enclosure type							
			1		3R		4		4X Stainless	
			Catalog number	List price	Catalog number	List price	Catalog number	List price	Catalog number	List price
	30	J	FJ301-3MB6B	\$ 1420	FJ303-3MB6B	\$ 1560	FJ304-3MB6B	\$ 2400	FJ30X-3MB6B	\$ 3500
	30	CC	FC301-3MB6B		FC303-3MB6B		FC304-3MB6B		FC30X-3MB6B	
	60	J	FJ601-3MB6B	1620	FJ603-3MB6B	1780	FJ604-3MB8B	2750	FJ60X-3MB8B	4050
	100	J	FJ1001-3MB8B	2220	FJ1003-3MB8B	2440	FJ1004-3MB8B	3750	FJ100X-3MB8B	5500
	200	J	FJ2001-3MB8C	4960	FJ2003-3MB8C	5360	FJ2004-3MB8C	8450	FJ200X-3MB8C	10,560
	400	J	FJ4001-3MB4C	8160	FJ4003-3MB4C	8960	FJ4004-3MB4C	17,730	FJ400X-3MB4C	22,160
	600	J	FJ6001-3MB4C	11,160	FJ6003-3MB4C	14,460	FJ6004-3MB4C	26,050	FJ600X-3MB4C	32,560
	800	L	FL8001-3MB4B	19,560	FL8003-3MB4B	22,960	FL8004-3MB4B	34,050	FL800X-3MB4B	42,560

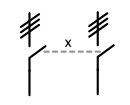
UL general purpose amp rating		Fuse type	NEMA Enclosure type			
			4X Plastic		12	
			Catalog number	List price	Catalog number	List price
	30	J	FJ30P-3MB6B	\$ 1750	FJ302-3MB6B	\$ 1650
	30	CC	FC30P-3MB6B		FC302-3MB6B	
	60	J	FJ60P-3MB8B	2020	FJ602-3MB6B	2020
	100	J	FJ100P-3MB8B	2750	FJ1002-3MB8B	2580
	200	J	FJ200P-3MB8C	9300	FJ2002-3MB8C	5360
	400	J	FJ400P-3MB4C	17,360	FJ4002-3MB4C	8960
	600	J	FJ600P-3MB4C	27,760	FJ6002-3MB4C	12,960
	800	L	FL800P-3MB4B	35,360	FL8002-3MB4B	20,160

## Bypass switches 30A – 800A

### 3 Pole Bypass switch, 600V, 30A – 800A

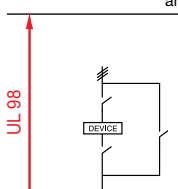
		NEMA Enclosure type								
		1		3R		4		4X Stainless		
UL general purpose amp rating	Fuse type	Catalog number	List price	Catalog number	List price	Catalog number	List price	Catalog number	List price	
	30	J	FJ301-3BB8B	\$ 1850	FJ303-3BB8B	\$ 2050	FJ304-3BB8B	\$ 3150	FJ30X-3BB8B	\$ 4550
	30	CC	FC301-3BB8B	—	FC303-3BB8B	—	FC304-3BB8B	—	FC30X-3BB8B	—
	60	J	—	—	—	—	—	—	—	—
	100	J	—	—	—	—	—	—	—	—
	200	J	FJ2001-3B8C	9000	FJ2003-3B8C	9800	FJ2004-3B8C	16,000	FJ200X-3B8C	19,950
	400	J	FJ4001-3B6C	15,300	FJ4003-3B6C	16,800	FJ4004-3B6C	34,000	FJ400X-3B6C	42,500
	600	J	FJ6001-3B6C	21,100	FJ6003-3B6C	27,000	FJ6004-3B6C	50,300	FJ600X-3B6C	62,800
	800	L	FL8001-3B6B	37,500	FL8003-3B6B	44,100	FL8004-3B6B	65,800	FL800X-3B6B	82,300

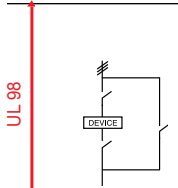
		NEMA Enclosure type				
		4X Plastic		12		
UL general purpose amp rating	Fuse type	Catalog number	List price	Catalog number	List price	
	30	J	FJ30P-3BB6B	\$ 2250	FJ302-3BB6B	\$ 2150
	30	CC	FC30P-3BB6B	—	FC302-3BB6B	—
	60	J	—	—	—	—
	100	J	—	—	—	—
	200	J	FJ200P-3B8C	17,600	FJ2002-3B8C	9800
	400	J	FJ400P-3B6C	33,100	FJ4002-3B6C	16,800
	600	J	FJ600P-3B6C	53,500	FJ6002-3B6C	24,600
	800	L	FL800P-3B6B	73,500	FL8002-3B6B	38,700

## Accessories ①②

Disconnect  
switches  
Fusible  
Enclosed



OESA-ZX157

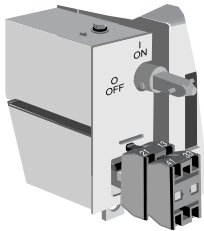

OZXK-1  
OZXK-2



3 Position selection switch



Pilot light

### Auxiliary contacts

For use on:	Contact configuration	Catalog number	Installation suffix	Installed list price adder
30A	1 N.O. + 1 N.C. 2 N.O. + 2 N.C.	OA4B1C	add "11" suffix add "22" suffix	<b>\$ 70</b> <b>110</b>
60A – 600A	1 N.O. 1 N.C.	OA1G10 OA3G01	add "10" suffix add "01" suffix	<b>30</b>
800A	1 N.O. & 1 N.C. 2 N.O. & 2 N.C.	OZXK-1 OZXK-2	add "11" suffix add "22" suffix	<b>130</b> <b>200</b>

### Accessories ①②

For use on:	Description	Installation suffix	Installed list price adder
30A	Neutral block	N	<b>\$ 40</b>
60A – 100A	Neutral block	N	<b>50</b>
200A – 400A	Neutral block	N	<b>150</b>
600A – 800A	Neutral block	N	<b>160</b>
30A – 200A	Service entrance, 3 wire Service entrance, 4 wire	U V	<b>75</b> <b>125</b>
400A – 800A	Service entrance, 3 wire Service entrance, 4 wire	U V	<b>150</b> <b>200</b>
30A – 800A	Start/stop pushbuttons 2 position selector switch 3 position selector switch Pilot light "red/run" Ammeter 1 phase ③ Voltmeter ③	A C D E AM VM	<b>68</b> <b>68</b> <b>78</b> <b>110</b> <b>940</b> <b>2300</b>

① Additional accessories can be found on pages 18.83 – 18.95.

② Please consult factory for special customer requirements.

③ Current transformers included.

## Technical data

### Other configuration descriptions

#### Conversion mechanisms

##### 6 or 8 pole

6 (8) pole mechanism allows two switches controlled by one handle to open or close simultaneously.

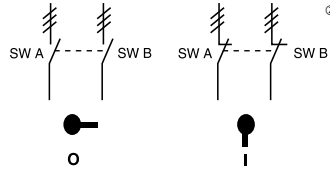

	POS. O	POS. I
SW. A	O	X
SW. B	O	X

X = Closed  
O = Open

##### Bypass<sup>①</sup>

Bypass mechanism operates three switches: Two switches in series and one changeover switch to allow power bypass.

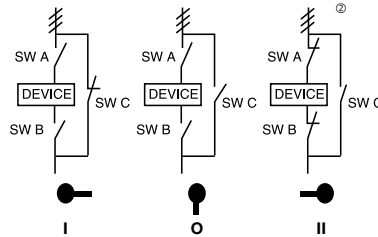

	POS. I	POS. O	POS. II
SW. A	O	O	X
SW. B	O	O	X
SW. C	X	O	O

X = Closed  
O = Open

##### Mechanical interlock

Mechanical interlock mechanism prevents both switches from being in the ON position at the same time.

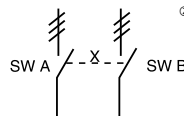

	SW. A POS. I	SW. B POS. O
SW. A	X	O
SW. B	O	X

X = Closed  
O = Open

<sup>①</sup> Transfer and bypass enclosed switches include the load side bussed or cabled together, and all switches come standard with ground lugs.

<sup>②</sup> = Three poles

## Approximate dimensions 2, 3 & 4 Pole ③ 30A – 800A Fusible

**Disconnect  
switches  
Fusible  
Enclosed**

### Fusible

Frame size	Enclosure type	H height	W width	D depth	MH mtg. height	MW mtg. width	Weight
OS30_	1	10.0	8.0	6.0	7.0	7.0	12
	3R	10.0	8.0	6.0	10.75	6.0	12
	4	10.0	8.0	6.0	10.75	6.0	12
	4X SS	10.0	8.0	6.0	10.75	6.0	12
	4X Plastic	10.0	8.0	5.9	10.75	6.0	8.0
OS60_	1	10.0	8.0	6.0	7.0	7.0	13
	3R	10.0	8.0	6.0	10.75	6.0	13
	4	10.0	8.0	6.0	10.75	6.0	13
	4X SS	10.0	8.0	6.0	10.75	6.0	13
	4X Plastic	10.0	8.0	5.9	10.75	6.0	9.0
OS100_	1	14.0	12.0	8.0	11.0	9.0	22
	3R	14.0	12.0	8.0	14.75	10.0	22
	4	14.0	12.0	8.0	14.75	10.0	22
	4X SS	14.0	12.0	8.0	14.75	10.0	22
	4X Plastic	14.0	12.0	8.0	14.75	10.0	16
OS200_	1	24.0	16.0	8.0	25.5	14.5	75
	3R	24.0	16.0	8.0	25.5	14.5	75
	4	24.0	16.0	8.0	25.5	14.5	75
	4X SS	24.0	16.0	8.0	25.5	14.5	75
	4X Plastic	①	①	①	①	①	①
12	24.0	16.0	8.0	25.5	14.5	75	

Frame size	Enclosure type	H height	W width	D depth	mtg. height	MW mtg. width	Weight
OS400_	1	36.0	24.0	12.0	37.5	22.5	150
	3R	36.0	24.0	12.0	37.5	22.5	150
	4	36.0	24.0	12.0	37.5	22.5	150
	4X SS	36.0	24.0	12.0	37.5	22.5	150
	4X Plastic	①	①	①	①	①	①
12	36.0	24.0	12.0	37.5	22.5	150	
OS600_	1	42.0	36.0	12.0	43.5	34.5	150
	3R	42.0	36.0	12.0	43.5	34.5	150
	4	42.0	36.0	12.0	43.5	34.5	150
	4X SS	42.0	36.0	12.0	43.5	34.5	150
	4X Plastic	①	①	①	①	①	①
12	42.0	36.0	12.0	43.5	34.5	150	
OES800_	1	48.0	24.0	12.0	49.5	22.5	170
	3R	48.0	24.0	12.0	49.5	22.5	170
	4	48.0	24.0	12.0	49.5	22.5	170
	4X SS	48.0	24.0	12.0	49.5	22.5	170
	4X Plastic	①	①	①	①	①	①
12	48.0	24.0	12.0	49.5	22.5	170	

- ① Please consult factory, enclosures are sized to suit specific customer needs.  
 ② Enclosure is free standing.  
 ③ Some 4-pole switches require larger enclosures. Please consult factory.

