

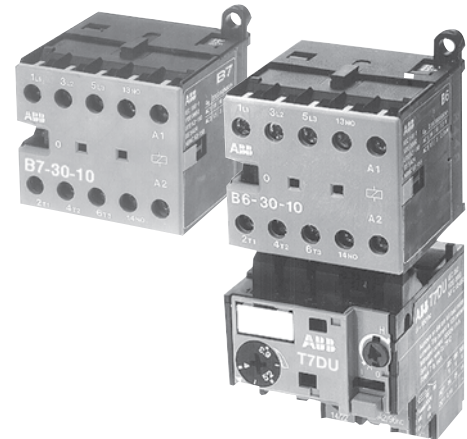

Miniature controls

- Contactors
- Overload relays
- Starters
- Control relays



Description

General features

- Wiring terminations available include plug-on connectors, wire pins for PC board mounting and solder connections
- Low power consumption coils
- Touch safe design: All screw connection terminals are protected against accidental touch
- Slotted Pozidriv terminal screws
- Screwdriver guide holes
- Self-lifting cable clamps
- Panel or DIN rail mounting
- Terminals supplied in the open position
- Electrically noiseless operation
- Snap-on accessories
- UL Listed, file # E39231
- CSA approved, file #LR15332
- IEC, VDE & most international standards

Contactors

- B6 and BC6 miniature contactors can be used for small motors up to 1 HP, 460V
- B7 and BC7 miniature contactors can be used for small motors up to 5 HP, 460V
- Applications include use in machines, electrical appliances, building automation systems, heating systems, overhead door applications, etc.
- B6 and B7 miniature contactors are designed to be directly connected to a PLC transistor output

Interface contactors

- “Interface” mini-contactors are normally used to establish an isolation between the electronic part and the process in large automation systems

Mechanically interlocked contactors

- Compact, mechanically interlocked contactors are available
- Can be used for reversing applications

Control relays

- AC & DC operated

Overload relays

- 14 setting ranges from 0.11 to 10.5 amps
- Manual or automatic reset
- Phase failure compensation
- Ambient temperature compensation
- Stop and test button functions
- UL Listed, file #E149922
- CSA approved, file # LR98336

Contactors

B6 & B7, non-reversing

3 Phase

4



B6C-1



B7C-1



B6CFP-1



B7CSP-1

Non-reversing with screw connections

General purpose AC1	Maximum motor FLA AC3	3 Phase motor horsepower				Single phase		Number of power poles	Auxiliary contacts	Catalog number	List price
		208V	230V	460V	600V	120V	230V				
AC operated											
12	6.8	1	2	3	1	1/2	1	3 3 4	1 N.O. 1 N.C. —	B6-30-10-Δ B6-30-01-Δ B6-40-00-Δ	\$ 51
16	9.6	2	3	5	5	1	2	3 3 4	1 N.O. 1 N.C. —	B7-30-10-Δ B7-30-01-Δ B7-40-00-Δ	72
DC operated											
12	6.8	1	2	3	1	1/2	1	3 3	1 N.O. 1 N.C.	BC6-30-10-Δ BC6-30-01-Δ	57
16	9.6	2	3	5	5	1	2	3 3	1 N.O. 1 N.C.	BC7-30-10-Δ BC7-30-01-Δ	78

Non-reversing with flat pin connections

General purpose AC1	Maximum motor FLA AC3	3 Phase motor horsepower				Single phase		Number of power poles	Auxiliary contacts	Catalog number	List price
		208V	230V	460V	600V	120V	230V				
AC operated											
12	6.8	1	2	3	1	1/2	1	3 3 4	1 N.O. 1 N.C. —	B6-30-10-FΔ B6-30-01-FΔ B6-40-00-FΔ	\$ 51
16	9.6	2	3	5	5	1	2	3 3 4	1 N.O. 1 N.C. —	B7-30-10-FΔ B7-30-01-FΔ B7-40-00-FΔ	72
DC operated											
12	6.8	1	2	3	1	1/2	1	3 3	1 N.O. 1 N.C.	BC6-30-10-FΔ BC6-30-01-FΔ	57
16	9.6	2	3	5	5	1	2	3 3	1 N.O. 1 N.C.	BC7-30-10-FΔ BC7-30-01-FΔ	78

Non-reversing with soldering pin connections

General purpose AC1	Maximum motor FLA AC3	3 Phase motor horsepower				Single phase		Number of power poles	Auxiliary contacts	Catalog number	List price
		208V	230V	460V	600V	120V	230V				
AC operated											
12	6.8	1	2	3	1	1/2	1	3 3 4	1 N.O. 1 N.C. —	B6-30-10-PΔ B6-30-01-PΔ B6-40-00-PΔ	\$ 51
16	9.6	2	3	5	5	1	2	3 3 4	1 N.O. 1 N.C. —	B7-30-10-PΔ B7-30-01-PΔ B7-40-00-PΔ	72
DC operated											
12	6.8	1	2	3	1	1/2	1	3 3	1 N.O. 1 N.C.	BC6-30-10-PΔ BC6-30-01-PΔ	57
16	9.6	2	3	5	5	1	2	3 3	1 N.O. 1 N.C.	BC7-30-10-PΔ BC7-30-01-PΔ	78

Coil voltage selection

Δ Coil voltage suffix. Refer to Coil Voltage Selection Chart and substitute the desired coil voltage suffix for the Δ.

Coil voltage selection chart

	Volts								
	12	24	42	48	110/125	110/120	220	220/240	380/415
AC 40-450 Hz	F	L	G			1		2	M
DC	U	Y	V	W	P		R		

Contactors

B6 & B7, mechanically interlocked

3 Phase

Miniature controls

4

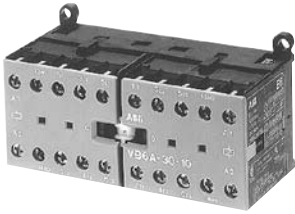

VB6M-1

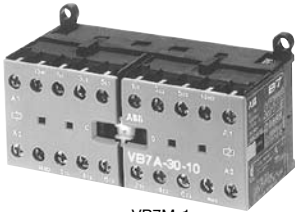

VB7M-1

Mechanically interlocked with screw connections

General purpose AC1	Maximum motor FLA AC3	3 Phase motor horsepower				Single phase		Number of power poles	Auxiliary contacts	Catalog number	List price
		208V	230V	460V	600V	120V	230V				
AC operated											
12	6.8	1	2	3	1	1/2	1	3	1 N.O. 1 N.C.	VB6-30-10-Δ VB6-30-01-Δ	\$ 104
16	9.6	2	3	5	5	1	2	3	1 N.O. 1 N.C.	VB7-30-10-Δ VB7-30-01-Δ	143
DC operated											
12	6.8	1	2	3	1	1/2	1	3	1 N.O. 1 N.C.	VBC6-30-10-Δ VBC6-30-01-Δ	105
16	9.6	2	3	5	5	1	2	3	1 N.O. 1 N.C.	VBC7-30-10-Δ VBC7-30-01-Δ	156

Mechanically interlocked with flat pin connections

General purpose AC1	Maximum motor FLA AC3	3 Phase motor horsepower				Single phase		Number of power poles	Auxiliary contacts	Catalog number	List price
		208V	230V	460V	600V	120V	230V				
AC operated											
12	6.8	1	2	3	1	1/2	1	3	1 N.O. 1 N.C.	VB6-30-10-FΔ VB6-30-01-FΔ	\$ 104
16	9.6	2	3	5	5	1	2	3	1 N.O. 1 N.C.	VB7-30-10-FΔ VB7-30-01-FΔ	143
DC operated											
12	6.8	1	2	3	1	1/2	1	3	1 N.O. 1 N.C.	VBC6-30-10-FΔ VBC6-30-01-FΔ	105
16	9.6	2	3	5	5	1	2	3	1 N.O. 1 N.C.	VBC7-30-10-FΔ VBC7-30-01-FΔ	156

Mechanically interlocked with soldering pin connections

General purpose AC1	Maximum motor FLA AC3	3 Phase motor horsepower				Single phase		Number of power poles	Auxiliary contacts	Catalog number	List price
		208V	230V	460V	600V	120V	230V				
AC operated											
12	6.8	1	2	3	1	1/2	1	3	1 N.O. 1 N.C.	VB6-30-10-PΔ VB6-30-01-PΔ	\$ 104
16	9.6	2	3	5	5	1	2	3	1 N.O. 1 N.C.	VB7-30-10-PΔ VB7-30-01-PΔ	143
DC operated											
12	6.8	1	2	3	1	1/2	1	3	1 N.O. 1 N.C.	VBC6-30-10-PΔ VBC6-30-01-PΔ	105
16	9.6	2	3	5	5	1	2	3	1 N.O. 1 N.C.	VBC7-30-10-PΔ VBC7-30-01-PΔ	156

Coil voltage selection

Δ Coil voltage suffix. Refer to Coil Voltage Selection Chart and substitute the desired coil voltage suffix for the Δ.

Coil voltage selection chart

	Volts									
	12	24	42	48	110/125	110/120	220	220/240	380/415	
AC 40-450 Hz		F	L	G		1		2		M
DC	U	Y	V	W	P		R			

Contactors ①

B6 & B7, Interface

3 Phase

4



BC6-2.4



BC7-2.4

Non-reversing with screw connections

General purpose AC1	Maximum motor FLA AC3	3 Phase motor horsepower				Single phase		Number of power poles	Auxiliary contacts	Catalog number	List price
		208V	230V	460V	600V	120V	230V				
DC operated – 24VDC (1.4W low power consumption)											
12	6.8	1	2	3	1	1/2	1	3	1 N.O. 1 N.C.	BC6-30-10-1.4 BC6-30-01-1.4	\$ 57
16	9.6	2	3	5	5	1	2	3	1 N.O. 1 N.C.	BC7-30-10-1.4 BC7-30-01-1.4	80
DC operated – 17 – 32VDC (2.4W low power consumption)											
12	6.8	1	2	3	1	1/2	1	3	1 N.O. 1 N.C.	BC6-30-10-2.4 BC6-30-01-2.4	63
16	9.6	2	3	5	5	1	2	3	1 N.O. 1 N.C.	BC7-30-10-2.4 BC7-30-01-2.4	80

Non-reversing with flat pin connections

General purpose AC1	Maximum motor FLA AC3	3 Phase motor horsepower				Single phase		Number of power poles	Auxiliary contacts	Catalog number	List price
		208V	230V	460V	600V	120V	230V				
DC operated – 24VDC (1.4W low power consumption)											
12	6.8	1	2	3	1	1/2	1	3	1 N.O. 1 N.C.	BC6-30-10-F1.4 BC6-30-01-F1.4	\$ 57
16	9.6	2	3	5	5	1	2	3	1 N.O. 1 N.C.	BC7-30-10-F1.4 BC7-30-01-F1.4	80
DC operated – 17 – 32VDC (2.4W low power consumption)											
12	6.8	1	2	3	1	1/2	1	3	1 N.O. 1 N.C.	BC6-30-10-F2.4 BC6-30-01-F2.4	63
16	9.6	2	3	5	5	1	2	3	1 N.O. 1 N.C.	BC7-30-10-F2.4 BC7-30-01-F2.4	80

Non-reversing with soldering pin connections

General purpose AC1	Maximum motor FLA AC3	3 Phase motor horsepower				Single phase		Number of power poles	Auxiliary contacts	Catalog number	List price
		208V	230V	460V	600V	120V	230V				
DC operated – 24VDC (1.4W low power consumption)											
12	6.8	1	2	3	1	1/2	1	3	1 N.O. 1 N.C.	BC6-30-10-P1.4 BC6-30-01-P1.4	\$ 57
16	9.6	2	3	5	5	1	2	3	1 N.O. 1 N.C.	BC7-30-10-P1.4 BC7-30-01-P1.4	80
DC operated – 17 – 32VDC (2.4W low power consumption)											
12	6.8	1	2	3	1	1/2	1	3	1 N.O. 1 N.C.	BC6-30-10-P2.4 BC6-30-01-P2.4	63
16	9.6	2	3	5	5	1	2	3	1 N.O. 1 N.C.	BC7-30-10-P2.4 BC7-30-01-P2.4	80

① Interface contactors cannot utilize auxiliary contacts.

Contactors

for connection to PLCs^①

3 Phase

Miniature controls



B6SC-2.8

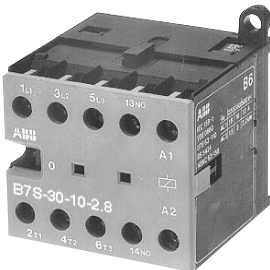

B7SC-2.8

Non-reversing with screw connections

General purpose AC1	Maximum motor FLA AC3	3 Phase motor horsepower				Single phase		Number of power poles	Auxiliary contacts	Catalog number	List price
		208V	230V	460V	600V	120V	230V				
DC operated – 24VDC (1.4W low power consumption)											
12	6.8	1	2	3	1	1/2	1	3	1 N.O. 1 N.C.	B6S-30-10-1.7 B6S-30-01-1.7	\$ 65
16	9.6	2	3	5	5	1	2	3	1 N.O. 1 N.C.	B7S-30-10-1.7 B7S-30-01-1.7	69
DC operated – 17 – 32VDC (2.4W low power consumption)											
12	6.8	1	2	3	1	1/2	1	3	1 N.O. 1 N.C.	B6S-30-10-2.8 B6S-30-01-2.8	65
16	9.6	2	3	5	5	1	2	3	1 N.O. 1 N.C.	B7S-30-10-2.8 B7S-30-01-2.8	69

Oscillograms typical operation

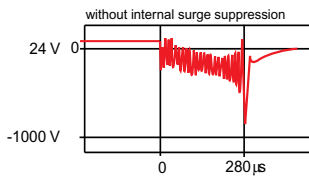

Switching off of interface contactors BC6, BC7, coil voltage 24 VDC.

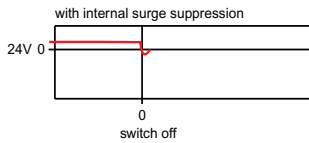

Switching off of B6S, B7S coil voltage 24VDC which provides electrically noiseless operation

① Contactors for connection to PLCs cannot utilize auxiliary contacts.

Thermal overload relays T7DU



T7DU

Thermal overload relay — for contactors B6, B7, BC6, BC7, B6S, B7S, VB6(7), VBC6(7), VB6A(7A), VBC6A(7A)

Setting range Amps	Catalog number	List price
0.1 – 0.16	T7DU0.16	\$ 48
0.16 – 0.24	T7DU0.24	
0.24 – 0.4	T7DU0.4	
0.4 – 0.6	T7DU0.6	
0.6 – 1.0	T7DU1.0	
1.0 – 1.6	T7DU1.6	
1.6 – 2.4	T7DU2.4	
2.4 – 4.0	T7DU4.0	
4.0 – 6.0	T7DU6.0	
6.0 – 9.0	T7DU9.0	
9.0 – 12.0	T7DU12.0	

Loading capacity of auxiliary switches

Type	T7DU			
	N.C. 95 – 96	N.O. 97 – 98		
Rated operating voltage U_e /V IEC / UL508	V	500 / 300	500 / 300	
Thermal current	A	6	6	
Rated operating current I_e	at AC-15 220/240 V	A	1.5	1.5
	at AC-15 380/415 V	A	0.7	0.5
	at AC-15 500 V	A	0.5	0.3
	at DC-15 220 V	A	0.2	0.2
Pilot duty rating	AC	A300	A300	
	DC	P300	P300	
General use	240V	1.5A	1.5A	
	600V	0.6A	0.6A	

Thermal overload relay T7DU

Setting range A – A	Short circuit protection (fuses, circuit breakers)				Resistance per phase W	Joule losses per phase at upper current setting W
	Coordination Type 2 (IEC) gL/gG A	Coordination Type 1(IEC) gL/gG A	600V, 5kA			
			Fuse	MCCB		
0.1 – 0.16	0.5	20	1	15A	62.3	1.6
0.16 – 0.24	1	20	1	15A	27	1.6
0.24 – 0.4	2	20	1	15A	11.7	1.9
0.4 – 0.6	2	20	1	15A	4.61	1.7
0.6 – 1.0	4	20	3	15A	1.66	1.7
1.0 – 1.6	6	20	6	15A	0.63	1.6
1.6 – 2.4	6	20	6	15A	0.27	1.6
2.4 – 4.0	10	20	15	15A	0.107	1.7
4.0 – 6.0	10	20	20	15A	0.049	1.8
6.0 – 9.0	10	20	35	15A	0.021	1.7
9.0 – 12.0	20	20	45	15A	0.010	1.4

Electronic overload relays

See pages 2.19 to 2.30.

Starters ①

B6 & B7, non-reversing

3 Phase

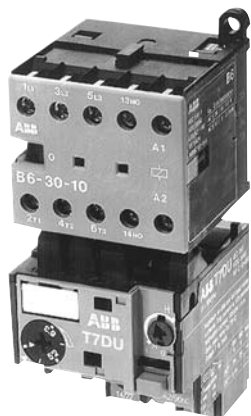

B6S-ΔΔ

Non-Reversing, 3 phase – Screw connections only

General purpose AC1	Maximum motor FLA AC3	3 Phase motor horsepower				Single phase		Number of power poles	Auxiliary contacts	Catalog number	List price
		208V	230V	460V	600V	120V	230V				
AC operated											
12	6.8	1	2	3	1	1/2	1	3	1 N.O. 1 N.C.	B6S-Δ‡ B6S-Δ01‡	\$ 108
16	9.6	2	3	5	5	1	2	3	1 N.O. 1 N.C.	B7S-Δ‡ B7S-Δ01‡	132
DC operated											
12	6.8	1	2	3	1	1/2	1	3	1 N.O. 1 N.C.	BC6S-Δ‡ BC6S-Δ01‡	114
16	9.6	2	3	5	5	1	2	3	1 N.O. 1 N.C.	BC7S-Δ‡ BC7S-Δ01‡	138

Δ Coil voltage suffix. Refer to Coil Voltage Selection chart and substitute the desired coil voltage suffix for the Δ.
‡ Overload relay suffix. Refer to the Overload Relay Selection chart and substitute the desired starter suffix code for the ‡.

Reversing, 3 phase – Screw connections only

General purpose AC1	Maximum motor FLA AC3	3 Phase motor horsepower				Single phase		Number of power poles	Auxiliary contacts	Catalog number	List price
		208V	230V	460V	600V	120V	230V				
AC operated											
12	6.8	1	2	3	1	1/2	1	3	1 N.O. 1 N.C.	B6SR-Δ‡ B6SR-Δ01‡	\$ 179
16	9.6	2	3	5	5	1	2	3	1 N.O. 1 N.C.	B7SR-Δ‡ B7SR-Δ01‡	218
DC operated											
12	6.8	1	2	3	1	1/2	1	3	1 N.O. 1 N.C.	BC6SR-Δ‡ BC6SR-Δ01‡	180
16	9.6	2	3	5	5	1	2	3	1 N.O. 1 N.C.	BC7SR-Δ‡ BC7SR-Δ01‡	231

Δ Coil voltage suffix. Refer to Coil Voltage Selection chart and substitute the desired coil voltage suffix for the Δ.
‡ Overload relay suffix. Refer to the Overload Relay Selection chart and substitute the desired starter suffix code for the ‡.

Coil voltage selection

	Volts								
	12	24	42	48	110/125	110/120	220	220/240	380/415
AC 40-450 Hz		F	L	G		1		2	M
DC	U	Y	V	W	P		R		

Overload relay selection

T7DU – Thermal overload

Catalog number	Current setting range	Starter range code
T7DU0.16	0.1 – 0.16	A
T7DU0.24	0.16 – 0.24	B
T7DU0.4	0.24 – 0.4	C
T7DU0.6	0.4 – 0.6	D
T7DU1.0	0.6 – 1.0	E
T7DU1.6	1.0 – 1.6	F
T7DU2.4	1.6 – 2.4	G
T7DU4.0	2.4 – 4.0	H
T7DU6.0	4.0 – 6.0	J
T7DU9.0	6.0 – 9.0	K
T7DU12.0	9.0 – 12.0	L

E16DU – Electronic overload

Catalog number	Current setting range	Current tripping class	Starter range code
E16DU0.32-10	0.1 – 0.32	10	A1
E16DU1.0-10	0.3 – 1.0	10	B1
E16DU2.7-10	0.9 – 2.7	10	C1
E16DU6.3-10	2.0 – 6.3	10	D1
E16DU18.9-10	5.7 – 18.9	10	E1
E16DU0.32-20	0.1 – 0.32	20	A2
E16DU1.0-20	0.3 – 1.0	20	B2
E16DU2.7-20	0.9 – 2.7	20	C2
E16DU6.3-20	2.0 – 6.3	20	D2
E16DU18.9-20	5.7 – 18.9	20	E2
E16DU0.32-30	0.1 – 0.32	30	A3
E16DU1.0-30	0.3 – 1.0	30	B3
E16DU2.7-30	0.9 – 2.7	30	C3
E16DU6.3-30	2.0 – 6.3	30	D3
E16DU18.9-30	5.7 – 18.9	30	E3

① For enclosed miniature starters, please consult factory for catalog number and pricing.

Starters ①

B6 & B7, Non-reversing

Single phase

Non-Reversing, Single phase – Screw connections only

General purpose AC1	Maximum motor FLA AC3	Single phase		Number of power poles	Auxiliary contacts	Catalog number	List price
		120V	230V				
AC operated							
12	6.8	1/2	1	3	1 N.O. 1 N.C.	B6SS-Δ‡ B6SS-Δ01‡	\$ 108
16	9.6	1	2	3	1 N.O. 1 N.C.	B7SS-Δ‡ B7SS-Δ01‡	132
DC operated							
12	6.8	1/2	1	3	1 N.O. 1 N.C.	BC6SS-Δ‡ BC6SS-Δ01‡	114
16	9.6	1	2	3	1 N.O. 1 N.C.	BC7SS-Δ‡ BC7SS-Δ01‡	138

Δ Coil voltage suffix. Refer to Coil Voltage Selection chart and substitute the desired coil voltage suffix for the Δ.

‡ Overload relay suffix. Refer to the Overload Relay Selection chart and substitute the desired starter suffix code for the ‡.

Coil voltage selection

	Volts								
	12	24	42	48	110/125	110/120	220	220/240	380/415
AC 40-450 Hz		F	L	G		1		2	M
DC	U	Y	V	W	P		R		

Overload relay selection

T7DU – Thermal overload

Catalog number	Current setting range	Starter range code
T7DU0.16	0.1 – 0.16	A
T7DU0.24	0.16 – 0.24	B
T7DU0.4	0.24 – 0.4	C
T7DU0.6	0.4 – 0.6	D
T7DU1.0	0.6 – 1.0	E
T7DU1.6	1.0 – 1.6	F
T7DU2.4	1.6 – 2.4	G
T7DU4.0	2.4 – 4.0	H
T7DU6.0	4.0 – 6.0	J
T7DU9.0	6.0 – 9.0	K
T7DU12.0	9.0 – 12.0	L

① For enclosed miniature starters, please consult factory for catalog number and pricing.

Control relays

K622 - K640

AC & DC operated



K640-1



KC631-1

Control relays with screw connections

	Contact configuration		Catalog number	List price
	N.O.	N.C.		
AC Operated	4 3 2	0 1 2	K640E-Δ K631Z-Δ K622Z-Δ	\$ 48
DC Operated	4 3 2	0 1 2	KC6-40E-Δ KC6-31Z-Δ KC6-22Z-Δ	54

Control relays with flat pin connections

	Contact configuration		Catalog number	List price
	N.O.	N.C.		
AC Operated	4 3 2	0 1 2	K6-40E-FΔ K6-31Z-FΔ K6-22Z-FΔ	\$ 48
DC Operated	4 3 2	0 1 2	KC6-40E-FΔ KC6-31Z-FΔ KC6-22Z-FΔ	54

Control relays with soldering pin connections

	Contact configuration		Catalog number	List price
	N.O.	N.C.		
AC Operated	4 3 2	0 1 2	K6-40E-PΔ K6-31Z-PΔ K6-22Z-PΔ	\$ 48
DC Operated	4 3 2	0 1 2	KC6-40E-PΔ KC6-31Z-PΔ KC6-22Z-PΔ	54

Coil voltage selection

Δ Coil voltage suffix. Refer to Coil Voltage Selection Chart and substitute the desired coil voltage suffix for the Δ.

Coil voltage selection chart

	Volts								
	12	24	42	48	110/125	110/120	220	220/240	380/415
AC 40-450 Hz		F	L	G		1		2	M
DC	U	Y	V	W	P		R		

Interface relays ①

KC631 - KC640

DC operated

4



KC640-1.4



BC7-2.4

Interface relays with screw connections

	Contact configuration		Catalog number	List price
	N.O.	N.C.		
DC Operated – 24VDC (1.4W low power consumption)	4	0	KC6-40E-1.4 KC6-31Z-1.4	\$ 59
	3	1		
DC Operated – 17 – 32VDC (2.4W low power consumption)	4	0	KC6-40E-2.4 KC6-31Z-2.4	59
	3	1		

Interface relays with flat pin connections

	Contact configuration		Catalog number	List price
	N.O.	N.C.		
DC Operated – 24VDC (1.4W low power consumption)	4	0	KC6-40E-F1.4 KC6-31Z-F1.4	\$ 59
	3	1		
DC Operated – 17 – 32VDC (2.4W low power consumption)	4	0	KC6-40E-F2.4 KC6-31Z-F2.4	59
	3	1		

Interface relays with soldering pin connections

	Contact configuration		Catalog number	List price
	N.O.	N.C.		
DC Operated – 24VDC (1.4W low power consumption)	4	0	KC6-40E-P1.4 KC6-31Z-P1.4	\$ 59
	3	1		
DC Operated – 17 – 32VDC (2.4W low power consumption)	4	0	KC6-40E-P2.4 KC6-31Z-P2.4	59
	3	1		

① Interface relays cannot utilize auxiliary contacts.

Accessories for B6 & B7 contactors

Miniature
controls

4



CA6-11K



CA6-11E-F



CA6-11K-P



CAF6-11M

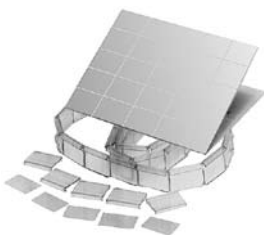

BA 50

Auxiliary contact blocks

Item description	Contact configuration	Catalog number ①	List price	
Side mounted auxiliary contact blocks, 1 N.O. & 1 N.C.				
Screw connection type				
<ul style="list-style-type: none"> KC6 & K6 relay B6 or BC6; B7 or BC7 4 pole contactor B6 or BC6; B7 or BC7 3 pole contactor, 1 N.O. B6 or BC6; B7 or BC7 3 pole contactor, 1 N.C. 	1 N.O. & 1 N.C. 1 N.O. & 1 N.C. 1 N.O. & 1 N.C. 1 N.O. & 1 N.C.	CA6-11K CA6-11E CA6-11M CA6-11N	\$ 15	
Flat pin connection type				
<ul style="list-style-type: none"> KC6 & K6 relay B6 or BC6; B7 or BC7 4 pole contactor B6 or BC6; B7 or BC7 3 pole contactor, 1 N.O. B6 or BC6; B7 or BC7 3 pole contactor, 1 N.C. 	1 N.O. & 1 N.C. 1 N.O. & 1 N.C. 1 N.O. & 1 N.C. 1 N.O. & 1 N.C.	CA6-11K-F CA6-11E-F CA6-11M-F CA6-11N-F		
Soldering pin connection type				
<ul style="list-style-type: none"> KC6 & K6 relay B6 or BC6; B7 or BC7 4 pole contactor B6 or BC6; B7 or BC7 3 pole contactor, 1 N.O. B6 or BC6; B7 or BC7 3 pole contactor, 1 N.C. 	1 N.O. & 1 N.C. 1 N.O. & 1 N.C. 1 N.O. & 1 N.C. 1 N.O. & 1 N.C.	CA6-11K-P CA6-11E-P CA6-11M-P CA6-11N-P		
Front mounted auxiliary contact blocks, 1 N.O. & 1 N.C.				
Screw connection type				
<ul style="list-style-type: none"> KC6 & K6 relay KC6 & K6 relay KC6 & K6 relay B6 or BC6; B7 or BC7 4 pole contactor, VB(C)... B6 or BC6; B7 or BC7 4 pole contactor, VB(C)... B6 or BC6; B7 or BC7 4 pole contactor, VB(C)... B6 or BC6; B7 or BC7 3 pole contactor, 1 N.O., VB(C)... B6 or BC6; B7 or BC7 3 pole contactor, 1 N.O., VB(C)... B6 or BC6; B7 or BC7 3 pole contactor, 1 N.O., VB(C)... B6 or BC6; B7 or BC7 3 pole contactor, 1 N.C., VB(C)... B6 or BC6; B7 or BC7 3 pole contactor, 1 N.C., VB(C)... B6 or BC6; B7 or BC7 3 pole contactor, 1 N.C., VB(C)... B6 or BC6; B7 or BC7 3 pole contactor, 1 N.C., VB(C)... 	1 N.O. & 1 N.C. 2 N.O. & 0 N.C. 0 N.O. & 2 N.C. 1 N.O. & 1 N.C. 2 N.O. & 0 N.C. 0 N.O. & 2 N.C. 1 N.O. & 1 N.C. 2 N.O. & 0 N.C. 0 N.O. & 2 N.C. 1 N.O. & 1 N.C. 0 N.O. & 2 N.C. 1 N.O. & 1 N.C. 2 N.O. & 0 N.C. 0 N.O. & 2 N.C.	CAF6-11K CAF6-20K CAF6-02K CAF6-11E CAF6-20E CAF6-02E CAF6-11M CAF6-20M CAF6-02M CAF6-11N CAF6-20N CAF6-02N		

Soldering connection

Item description	Catalog number	List price
For mini contactors, B, BC, K, & KC	LB6	\$ 15
For 2 pole auxiliary contacts	LB6-CA	8

Plunger

Item description	Catalog number	List price
For manual operation	BN6	\$ 15

Identification labels

Item description	Catalog number	List price
50 clip-on label holders, 60 non-adhesive labels 50 transparent covers, 75 self adhesive labels	BA50	\$ 30

① Miniature contactors and control relays can use either front or side mounted auxiliary blocks but not both.

Accessories for B6 & B7 contactors

4



RV-BC6/...



LT6-B



Load side (T)
BSM6-30

Surge suppressors

Item description	Voltage	Catalog number	List price
Varistor type surge suppressor for DC operated coils	24 - 60V 110 - 250V 200 - 420V	RV-BC6/60 RV-BC6/250 RV-BC6/380	\$ 24



Protective cover

Item description	Catalog number	List price
For contactors B, BC, K, & KC6 with screw connection	LT6-B	\$ 15

Reversing connection link

Item description	Catalog number	List price
For compact interlocking contactors with screw connection	BSM6-30	\$ 12

D.C. Power circuit switching

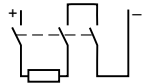
Utilization category			DC-1 L/R ≤ 1 ms	DC-3 L/R ≤ 2 ms	DC-5 L/R ≤ 7.5 ms
	24 V	A	16.0	16.0	16.0
	48 V	A	16.0	8.0	2.0
	60 V	A	16.0	4.0	1.25
	110 V	A	7.0	1.5	0.4
	220 V	A	0.8	0.25	0.2
	24 V	A	16.0	16.0	16.0
	48 V	A	16.0	16.0	16.0
	60 V	A	16.0	15.0	12.0
	110 V	A	16.0	7.0	2.0
	220 V	A	5.0	1.5	0.5
	24 V	A	16.0	16.0	16.0
	48 V	A	16.0	16.0	16.0
	60 V	A	16.0	16.0	16.0
	110 V	A	16.0	15.0	8.0
	220 V	A	14.0	4.0	2.0

4

Electrical durability curves for DC-1, DC-3 and DC-5

The curves below take into account the time constant L/R for each utilization category and show the electrical durability of the contactors during DC-1, DC-3 and DC-5 use for 3 poles connected in series.

If one single pole is used, the corresponding breaking capacity (W) is reduced to 1/3 and for 2 poles connected in series it is reduced to 2/3.

- A = DC-1 3 poles in series
- B = DC-3 3 poles in series
- C = DC-5 3 poles in series

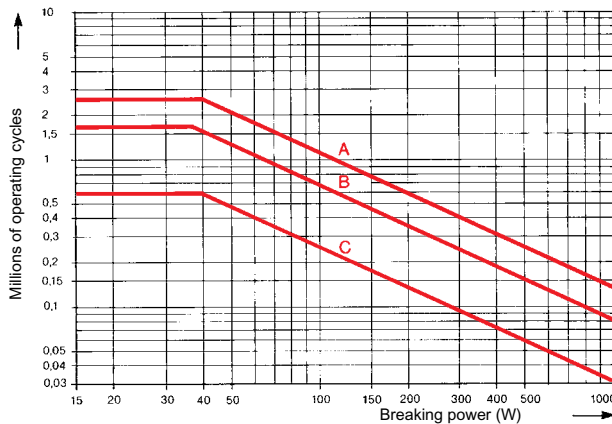

IEC Technical data

B6 Contactors & K6 control relays

Auxiliary contacts & magnetic coils

4

Endurance curves – B 6, BC 6, B 6S

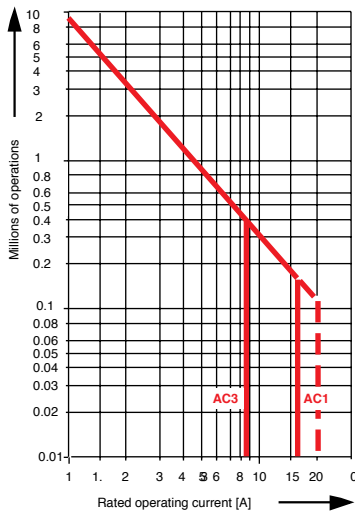

Endurance curves – B 6, BC 6, B 6S

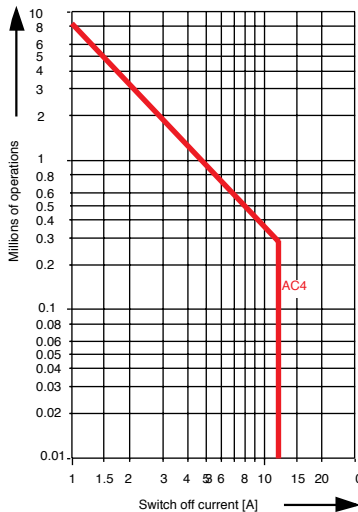

Endurance curves – K6, KC6, CA6, CAF6

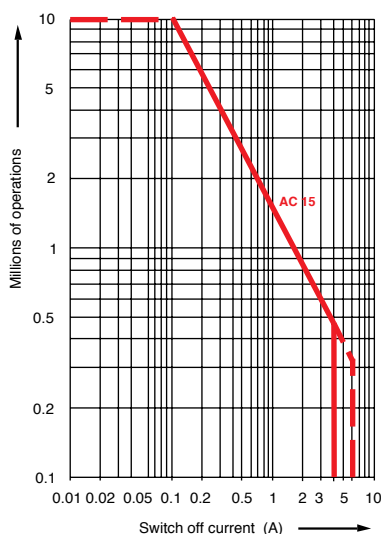

B6 contactors

Rated insulating voltage	V_i	500			
Permissible ambient temperature					
Contactor without relay	°C	- 25 ... + 55			
Contactor with relay	°C	- 25 ... + 50			
Storage temperature	°C	- 40 ... + 80			
Climatic resistance	acc. to DIN 50 017 acc. to UTE C 63-100	alternating climate proof 30 cycles, version 1			
Mounting position		optional			
Mechanical endurance	10 million operations				
Max. switching frequency	AC 1 cyc./h AC 2/AC 3 cyc./h	300 600			
Rated operating voltage V_e	V AC	12 to 500			
Rated operating current I_e /AC 1, AC 3		AC 1/ I_e A		AC 2, AC 3	
Rated operating power		55 °C	40 °C	I_e A	P kW
	220/240 V	16	20	9	2.2
	380/440 V	16	20	9/8	4.0
	500 V	12	12	5.5	3.0
Switching times		B6	BC6	K6	KC6
Closing delay	NO ms	20 to 26		20 to 26	
Opening delay	NO ms	16 to 20	4 to 6	16 to 20	4 to 6
Closing delay	NC ms	16 to 20	4 to 6	16 to 20	4 to 6
Opening delay	NC ms	14 to 18		14 to 18	

K6 Control relays & auxiliary contacts

Rated operating voltage V_e	VDC VAC	12 to 240 12 to 500
Conventional rated thermal current I_{th}	A	6
Rated operating current I_e /AC 15 at V_e		
	220/240 V A	4
	380/440 V A	3
	500 V A	2
Rated operating current I_e /DC 13 at V_e		
	24 V A	2.5
	60 V A	1.2
	110 V A	0.7
	220/240 V A	0.4

Magnetic coils

Coil voltage range	0.8 ... 1.1x U_e			
Basic contactors	closing /holding			
B6 / K6, VB6	AC	VA	3.5	
BC6 / KC 6, VBC6	DC	W	3.5	
Interface contactors				
BC6 / KC6-1.4	DC	• 24 • V W	1.4	
BC6 / KC6-2.4	DC	17 ... 32 V W	2.4	
Mini contactor for connection to PLC's			cold	
			I mA	P W
B6 S-1.7	DC	+ 24 + V W	77	1.75
B6 S-2.8	DC	+ 17 ... 32 + V W	125	2.80
			warm	
			I mA	P W
			60	1.35
			94	2.10

IEC Technical data

B7 contactors

Magnetic coils

Miniature controls

4

Endurance curves – B 7, BC 7, B 7S

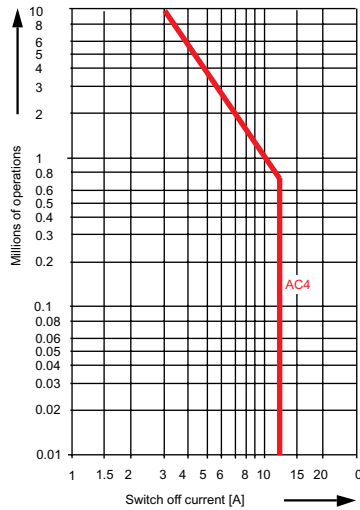
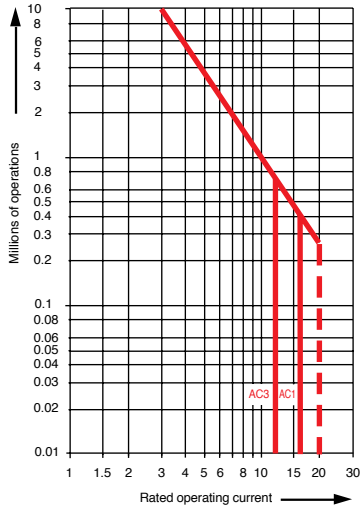

B7 contactors

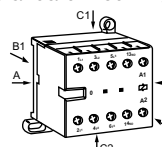
Rated insulating voltage	V_i	500				
Permissible ambient temperature						
Contactor without relay	°C	- 25 ... + 55				
Contactor with relay	°C	- 25 ... + 50				
Storage temperature	°C	- 40 ... + 80				
Climatic resistance	acc. to DIN 50 017 acc. to UTE C 63-100	alternating climate proof 30 cycles, version 1				
Mounting position		optional				
Mechanical endurance	10 million operations					
Max. switching frequency	AC 1 cyc./h AC 2/AC 3 cyc./h	300 600				
Rated operating voltage V_e	VAC	12 to 500				
Rated operating current I_e /AC 1, AC 3		AC 1/ I_e A		AC 2, AC 3		
Rated operating power		55 °C	40 °C	I_e A	P kW	
	220/240 V	16	20	12/11	3	
	380/440 V	16	20	12/11	5.5	
	500 V	12	12	7	4	
Switching times		B7	BC7			
Closing delay	NO	20 to 26				
Opening delay		16 to 20	4 to 6			
Closing delay	NC	16 to 20				
Opening delay		14 to 18				
Shock resistance B6, B7 standard mounting position		1/2 sinusoidal shock, 10 ms: no change in contact position				
		shock directions contactor switched on contactor switched off				
		A	B1	B2	C1	C2
		20 g	20 g	20 g	20 g	20 g
		10 g	20 g	20 g	20 g	20 g

Magnetic Coils

Coil voltage range	0.8...1.1x U_c					
Rated power of magnetic coils	closing /holding					
Basic contactors						
B7 / VB7	AC	VA	3.5			
BC7 / VBC7	DC	W	3.5			
Interface contactors						
BC7-1.4	DC	+ 24 V	1.4			
BC7-2.4	DC	+17 ... 32 V	2.4			
Mini contactor for connection to PLC's			cold		warm	
			I (mA)	P (W)	I (mA)	P (W)
B7 S-1.7	DC	+ 24 V	77	1.75	60	1.35
B7 S-2.8	DC	+17 ... 32 V	125	2.80	94	2.10

Switching of light fittings

The following tables show the number of lamps which can be connected per phase at 230 V/ 60 Hz. Note the following:

- 4 a) Increased current consumption for 1.1 times the rated voltage is considered.
- b) Failure of about 5% of the lamps is considered since not ignited lamps additionally charge the contactor with their preheating current.
- c) This data only apply to connection of the lamps at main pole terminals 1 ...8

Lamp type number phase Hz) type BC6, BC7	Lamp data			Permissible of lamps per (230 V, 60 for contactor A B6, B7, cm
			Watt	
Incandescent lamps	60		0.27	20
	100		0.45	12
	200		0.91	6
	300		1.36	4
	500		2.27	2
	1000		4.5	1
Fluorescent lamps uncompensated	15	44	0.35	25
	20	59	0.37	23
	40	120	0.43	20
	42	105	0.54	16
	65	150	0.67	12
	115	120	1.5	5
	140	150	1.5	5
Fluorescent lamps in two-lamp circuit	2 x 20	59	2 x 0.13	2 x 26 lamp pairs
	2 x 40	120	2 x 0.22	2 x 20
	2 x 42	105	2 x 0.24	2 x 16
	2 x 65	150	2 x 0.34	2 x 12
	2 x 115	120	2 x 0.65	2 x 5
	2 x 140	150	2 x 0.75	2 x 5
Metal halogen lamps uncompensated	35		0.53	10
	70		1.0	5
	150		1.8	3
	250		3.0	2
	400		3.5	1
Low pressure sodium vapor lamps uncompensated	35		1.5	4
	55		1.5	4
	90		2.4	2
	135		3.5	2
	150		3.3	2
	180		3.3	2
	200		2.3	2
High pressure mercury vapor lamps uncompensated	150		1.8	3
	250		3.0	2
	330		3.7	2
	400		4.7	1
High pressure mercury vapor lamps uncompensated	50		0.61	10
	80		0.8	7
	125		1.15	5
	250		2.15	3
	400		3.25	2
	700		5.40	1

Endurance curves for DC1, DC3, DC5

The following shows endurance curves for DC1, DC3 and DC5 for 3 poles in series. If only one current path is used, the corresponding breaking capacity is multiplied by 0.33, for two current paths by 0.66.

Varying time constants L/R (ms) have been considered.

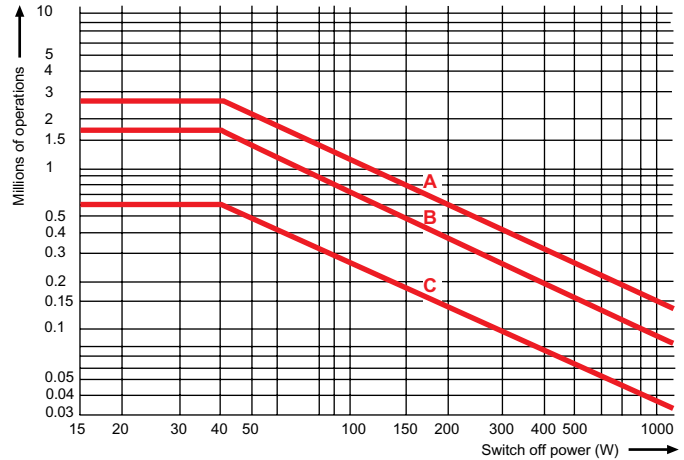

A = 3 poles in series DC 1
 B = 3 poles in series DC 3
 C = 3 poles in series DC 5

IEC Technical data

Pole configurations

Miniature contactors

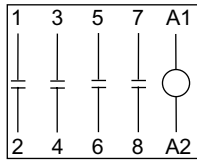

B6(7)-40-00 ...
BC6(7)-40-00 ...

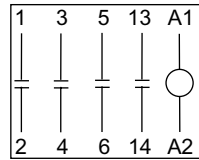

B6(7)-30-10 ...
BC6(7)-30-10 ...

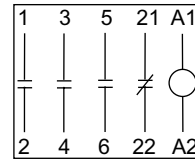

B6(7)-30-01 ...
BC6(7)-30-01 ...

Miniature mechanically interlocked contactors

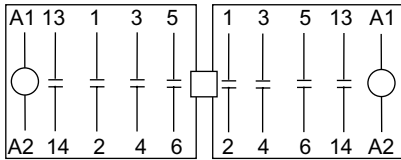

VB6(7)-30-10 ...
VBC6(7)-30-10 ...

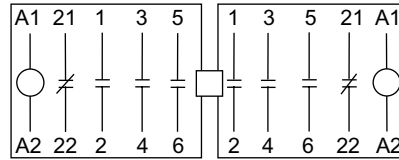

VB6(7)-30-01 ...
VBC6(7)-30-01 ...

Miniature control relays

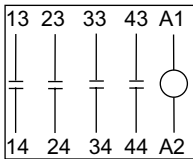

K6-40 E ...
KC6-40 E ...

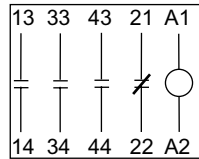

K6-31 Z ...
KC6-31 Z ...

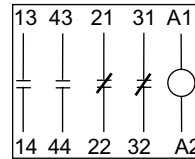

K6-22 Z ...
KC6-22 Z ...

Side mounted auxiliary contact blocks

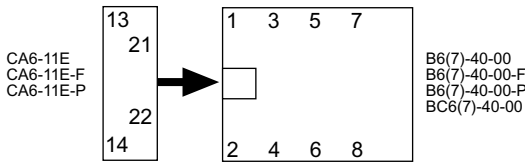

B6(7)-40-00
B6(7)-40-00-F
B6(7)-40-00-P
BC6(7)-40-00

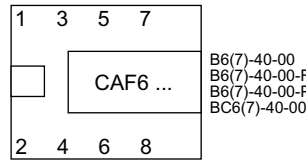

B6(7)-40-00
B6(7)-40-00-F
B6(7)-40-00-P
BC6(7)-40-00

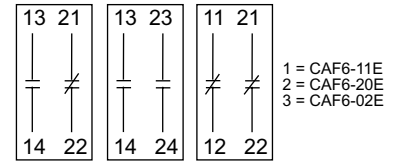

1 = CAF6-11E
2 = CAF6-20E
3 = CAF6-02E

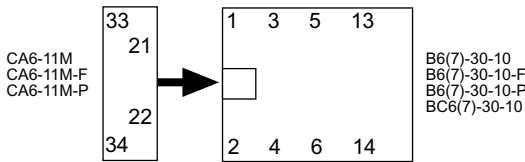

B6(7)-30-10
B6(7)-30-10-F
B6(7)-30-10-P
BC6(7)-30-10

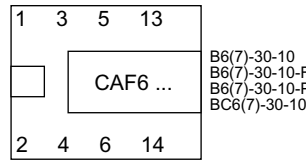

B6(7)-30-10
B6(7)-30-10-F
B6(7)-30-10-P
BC6(7)-30-10

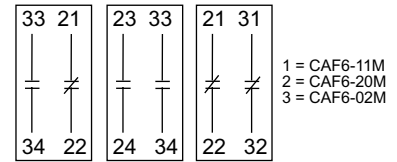

1 = CAF6-11M
2 = CAF6-20M
3 = CAF6-02M

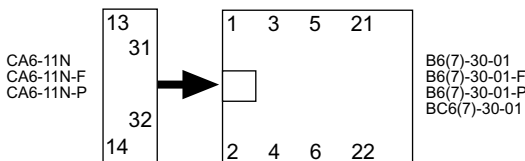

B6(7)-30-01
B6(7)-30-01-F
B6(7)-30-01-P
BC6(7)-30-01

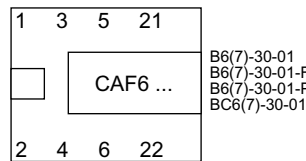

B6(7)-30-01
B6(7)-30-01-F
B6(7)-30-01-P
BC6(7)-30-01

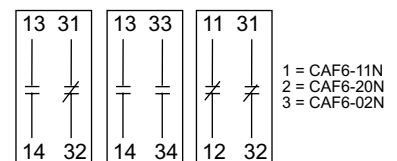

1 = CAF6-11N
2 = CAF6-20N
3 = CAF6-02N

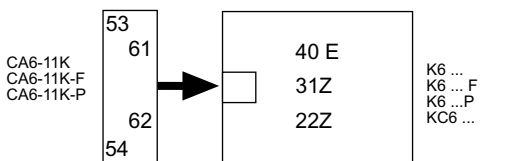

K6 ...
K6 ... F
K6 ... P
KC6 ...

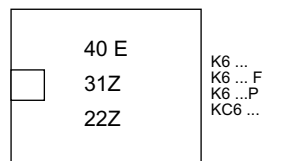

K6 ...
K6 ... F
K6 ... P
KC6 ...

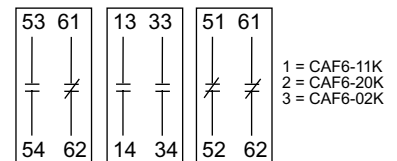

1 = CAF6-11K
2 = CAF6-20K
3 = CAF6-02K

NOTE: Only side mounted type or front mounted type auxiliary contact blocks can be used at one time. Auxiliary contact blocks must not be mounted on Interface contactors, Interface control relays or contactors for connection to PLCs. Two CAF 6 front mounted auxiliary contact blocks can be installed on the mechanically interlocked contactors VB(C)6(7).

IEC technical data

Overload relays

Type		T7DU
Standards: (major international and European standards)		IEC 947-4-1, UL 508 EN 60 947-4-1
Approvals, certificates		UL, CSA
Rated insulation voltage U _i acc. to IEC 158-1, IEC 947-4-1 acc. to IEC / UL 508Ui/V660V / 600V	V	690V
Impulse withstand voltage U _{impkV6} acc. to IEC 947-4-1		
Permissible ambient temperature	<ul style="list-style-type: none"> • for storage °C • with compensated operation °C – open °C – enclosed °C 	-40 to 70 -25° to + 50°C -25° to + 40°C
Climatic resistance according to		IEC 68-2-3, IEC 68-2-30
Mounting position		±30° from vertical position not horizontally, not upside down Side by side mounting distance, 5 _{mm}
Resistance to shock *Critical shock direction A1, A2	Shock duration ms multiple of g	10 10
Resistance to vibrations (±1 mm, 50 Hz)	multiple of g	–
Mounting	• on contactor	Hooking underneath the contactor, screwing on its main terminal
Terminal types and connecting capacity of main conductors (on motor side)	<ul style="list-style-type: none"> • Screw terminals (screw size) <ul style="list-style-type: none"> • with self-disengaging clamping piece • with terminal block • with busbar or cable lugs • connection cross sections <ul style="list-style-type: none"> • single-core or stranded Awg/mm² • flexible with connector sleeve mm² 	M3.5 – – 2 x 18 – 14 / 2 x 0.75 – 2.5 2 x 0.5 – 1.5
Terminals and auxiliary conductors	<ul style="list-style-type: none"> • Screw terminals (screw size) <ul style="list-style-type: none"> • with self-disengaging clamping piece • connection cross sections <ul style="list-style-type: none"> • single-core or stranded Awg/mm² • flexible with connector sleeve mm² 	M3.5 2 x 18 – 14 / 2 x 0.75 – 2.5 2 x 0.5 – 1.5
Protection degree to IEC 947-1/EN 60 947-1		All terminals are safe from finger-touch and touch by the back of the hand in accordance with VDE 0106, Part 100
Power pole technical data		
Number of poles	3	
Setting ranges		see order codes
Tripping class acc. to IEC 947-4-1/EN 60 947-4-1		10A
Frequency limit	Hz	0 – 400
Switching frequency up to 15 ops./h or 60 ops./h with 40% on load factor without early tripping if starting current not higher than 6 x I _n and starting time not longer than 1s.		

Approvals

UL USA	CSA Canada	EZU Czech. Republic	PTB Germany	GL Germany	LRS Great Britain	
☒	☒	☒	☒	☒	☒	

Legend:

- ☒ Standard design approved: identification plates bear the approval marks if it is mandatory
- ☒ Submitted for approval

Approximate dimensions Mini contactors & overload relays

Miniature
controls

00.00 Inches
00.00 [Millimeters]

Mini contactors AC & DC Operated – B6, BC6, B7, BC7

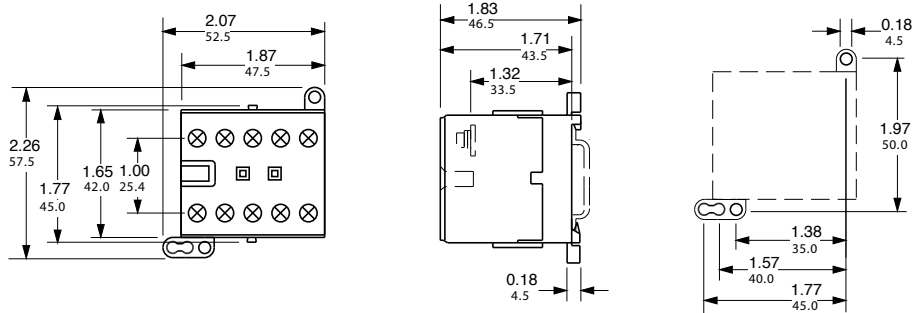

Mini contactor with overload relay B6, B7 & T7DU

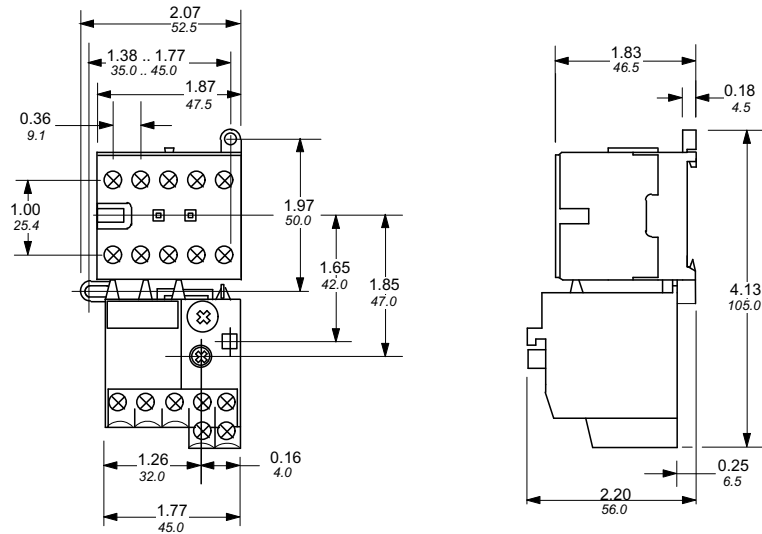

E16DU with B/BC6, B/BC7

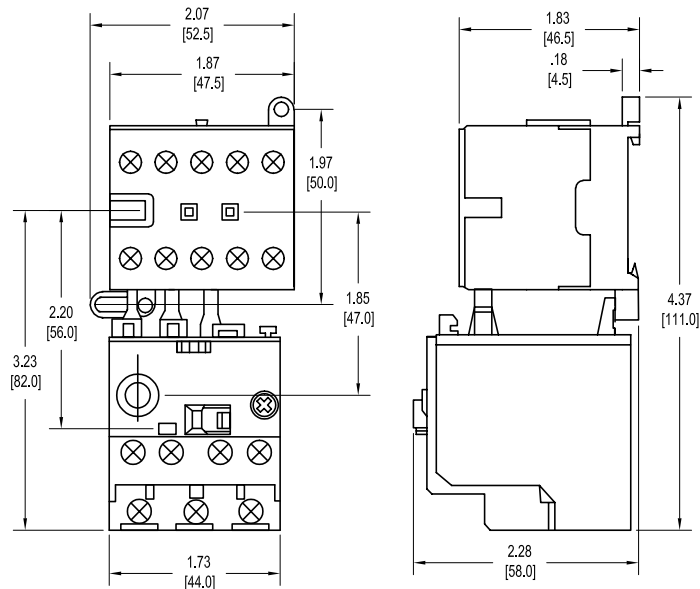

Approximate dimensions

Mechanically interlocked contactors, control relays

Auxiliary contact blocks

00.00 Inches
00.00 [Millimeters]

Mechanically interlocked – AC & DC Operated

VB6M, VBC6M, VB7M, VBC7M

4

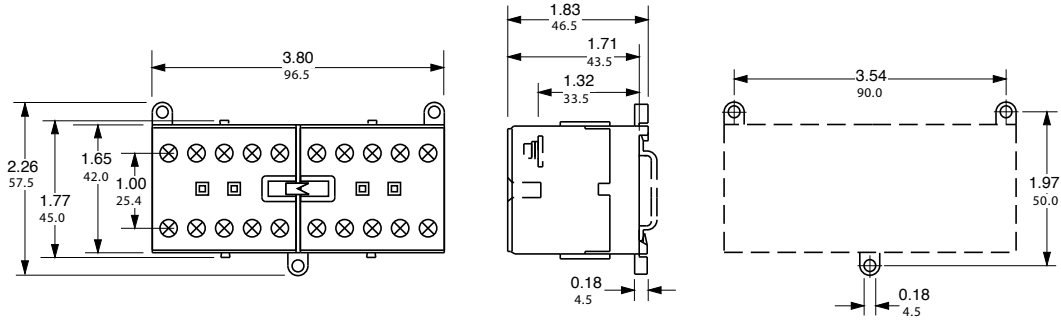

Mini control relays

AC & DC Operated – K6, KC6

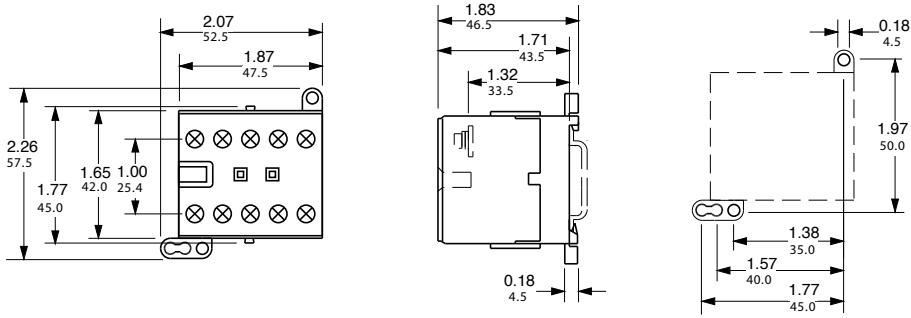

Mini contactor with side mounted auxiliary contact block

B6, B7 & CA6

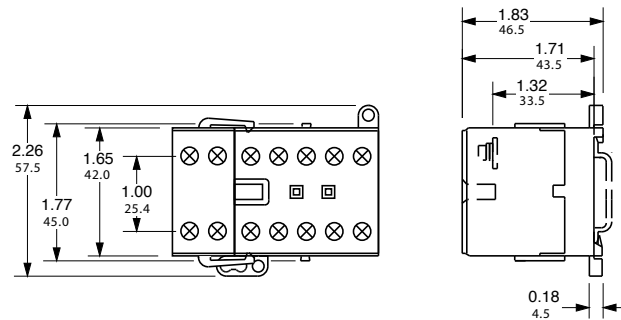

Mini contactor with front mounted auxiliary contact block

B6, B7 & CA6

