







## Two-position selector switches Non-illuminated

### Operator ...

Symbol	Handle color	Catalog No.	Ref. Code	List Price
<b>with short handle</b> ①				
<b>Maintained</b>				
	Red	<b>M2SS1-10R</b>	1SFA 611 200 R1001	\$ 11.00
	Black	<b>M2SS1-10B</b>	1SFA 611 200 R1006	
	Grey	<b>M2SS1-10U</b>	1SFA 611 200 R1007	
<b>Maintained</b>				
	Red	<b>M2SS2-10R</b>	1SFA 611 201 R1001	\$ 11.00
	Black	<b>M2SS2-10B</b>	1SFA 611 201 R1006	
	Grey	<b>M2SS2-10U</b>	1SFA 611 201 R1007	
<b>Momentary, spring return from C to B</b>				
	Red	<b>M2SS3-10R</b>	1SFA 611 202 R1001	14.00
	Black	<b>M2SS3-10B</b>	1SFA 611 202 R1006	
	Grey	<b>M2SS3-10U</b>	1SFA 611 202 R1007	
<b>with long handle</b> ①				
<b>Maintained</b>				
	Red	<b>M2SS4-10R</b>	1SFA 611 203 R1001	11.00
	Black	<b>M2SS4-10B</b>	1SFA 611 203 R1006	
	Grey	<b>M2SS4-10U</b>	1SFA 611 203 R1007	
<b>Maintained</b>				
	Red	<b>M2SS5-10R</b>	1SFA 611 204 R1001	11.00
	Black	<b>M2SS5-10B</b>	1SFA 611 204 R1006	
	Grey	<b>M2SS5-10U</b>	1SFA 611 200 R1007	
<b>Momentary, spring return from C to B</b>				
	Red	<b>M2SS6-10R</b>	1SFA 611 205 R1001	14.00
	Black	<b>M2SS6-10B</b>	1SFA 611 205 R1006	
	Grey	<b>M2SS6-10U</b>	1SFA 611 205 R1007	

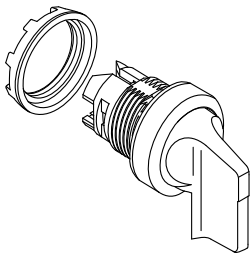
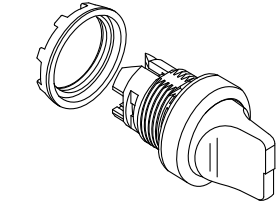

Bezel in black plastic as standard  
Bezel in metal:  
Replace '1' in the:  
Catalog No. M2SSX-1 0X  
Ref. Code 1SFA61 XXX R 1XXX  
3 for metal bezel  
4 for grey plastic bezel

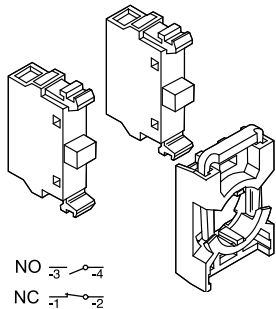

### Contact functions

Block positions as seen from operator front.

Handle position	Left block	Right block
A (B)	O	O
C	x	x

O = not actuated (normal state)  
x = actuated (state changed)

### Contact blocks and holder

Blocks	Catalog No.	Ref. Code	List Price
1 NO with holder	<b>MCBH-10</b>	1SFA 611 605 R1101	\$ 10.00
1 NC with holder	<b>MCBH-01</b>	1SFA 611 605 R1110	10.00
2 NO with holder	<b>MCBH-20</b>	1SFA 611 605 R1102	18.00
2 NC with holder	<b>MCBH-02</b>	1SFA 611 605 R1120	18.00
1 NO + 1 NC with holder	<b>MCBH-11</b>	1SFA 611 605 R1111	18.00
1 NO without holder	<b>MCB-10</b>	1SFA 611 610 R1001	8.00
1 NC without holder	<b>MCB-01</b>	1SFA 611 610 R1010	8.00
Holder for 3 blocks	<b>MCBH-00</b>	1SFA 611 605 R1100	2.00

### Ordering example

Requested: A non-illuminated modular selector switch. Black.  
Maintained.  
Handle positions: A and C  
With 2 NC contacts

Ref.: 1 piece of M2SS2-10B + 1 piece of MCBH-02

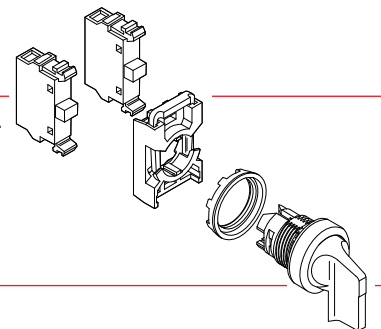

① No contact block in the center position