

Inductive 4 Wire DC Sensing range: 5mm – 8mm

Operating distance		5mm	8mm
Catalog number		SIF5M18NV2PK SIF5M18NV2NK	SIN8M18NV2PK SIN8M18NV2NK
List price		\$ 84.00	\$ 85.00
Sensor mounting		Shielded	Non-shielded
Output			
Suffix PK		PNP N.O. + N.C.	PNP N.O. + N.C.
Suffix NK		NPN N.O. + N.C.	NPN N.O. + N.C.
Operating voltage	VDC	10 – 30	10 – 30
Load current	mA	200	200
Switching frequency	Hz	800	700
No load supply current	mA	20	20
Voltage drop	VDC	2	3
Short circuit protection		yes	yes
Reverse polarity protection		yes	yes
Output indication		LED yellow	LED yellow
Operating temperature	°F	-13 ... +158	-13 ... +158
Protection			
IEC		IP67	IP67
Approvals			
CE		yes	yes
UL Listed		yes	yes
CSA		yes	yes
Wire size		22 AWG/0.34mm ²	22 AWG/0.34mm ²
Housing material		Nickel-plated brass	Nickel-plated brass
Housing diameter	mm	18	18
Sensing face		Crastin	Crastin
Connection		2 m, PVC cable	2 m, PVC cable



10

Approximate dimensions

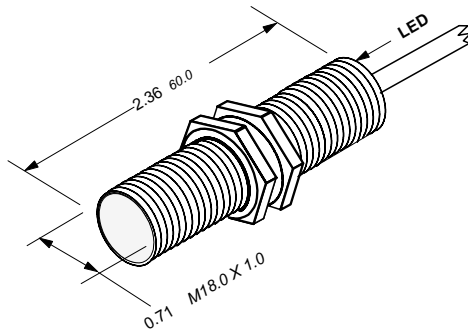

Approximate dimensions

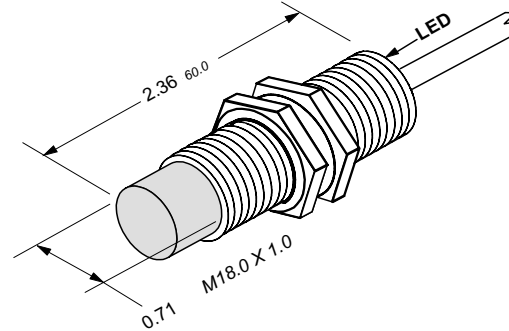

Wiring diagrams

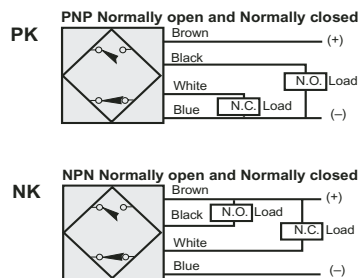

Wiring diagrams

