

Inductive

Weld field immune, 3 Wire DC
Sensing range: 8mm

Operating distance		8mm
Catalog number		SIN8M18WC1PO
List price		\$ 110.00
Sensor mounting		Non-shielded
Output		PNP Normally Open
Suffix PO		
Suffix NO		
Operating voltage	VDC	10 – 30
Load current	mA	200
Switching frequency	Hz	500
No load supply current	mA	15
Voltage drop	VDC	3
Short circuit protection		yes
Reverse polarity protection		yes
Output indication		Ring LED yellow
Weld field limit		
AC field	mT	150
DC field	mT	150
Operating temperature	°F	-13 ... +158
Protection		
IEC		IP67
Approvals		
CE		yes
UL Listed		yes
CSA		yes
Housing material		Teflon-coated brass
Housing diameter	mm	18
Sensing face		Teflon-coated Ryton
Connection		Connector M12



10

Approximate dimensions

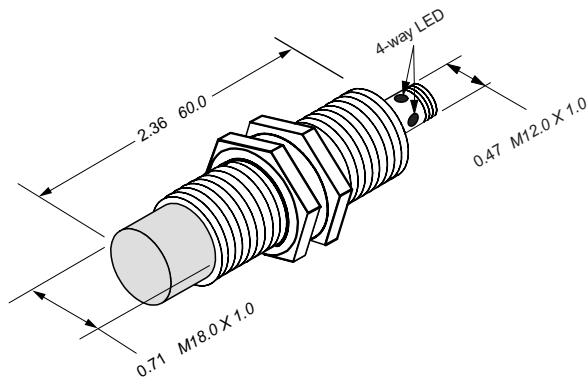

Wiring diagrams

