

Other configurations

Side operated ①

30A – 400A, UL fuse class J,CC,T

For a complete assembly,
please select one of each:

- 1 switch
- 1 handle
- 1 shaft
- 1 terminal lug



OS30A_S_



OXP5X170



OHY65J5TE00S



OS60JS30

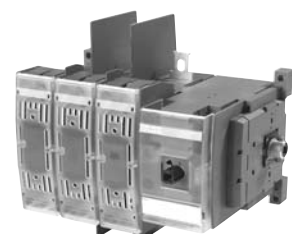

OS100JS30

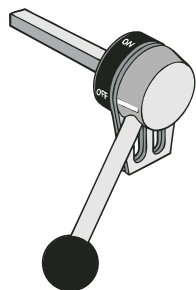

OETL-ZX74



OXP12X325



OZXA-25

Side operated switches — 3 pole

UL general purpose amp rating	UL fuse type 600V	Maximum horsepower rating					Weight (lbs)	Catalog number	List price
		Three phase							
		200V	208V	240V	480V	600V			
30	J	5	7.5	7.5	15	20	1.54	OS30AJS30	\$ 360
30	CC	5	7.5	7.5	15	20	1.54	OS30ACCS30	360
60	J	15	15	15	30	50	3.52	OS60JS30	540
100	J ^①	25	25	30	60	75	3.97	OS100JS30	640
200	J ^②	50	50	60	125	150	15.21	OES200J3-S	1800
400	J ^②	100	125	125	250	350	17.20	OES400J3-S	2600

Handles

UL/NEMA type	IEC type	Color	Length inches/mm	Marking	Defeat-able	Padlock-able	Weight	Catalog number	List price
For use with OS30A_S30									
1, 3R, 12	IP65	Black	2.6/65	OFF/ON	Yes	Yes	0.29	OHB65J5	\$ 80
1, 3R, 12	IP65	Red/Yel	2.6/65	OFF/ON	Yes	Yes	0.29	OHY65J5	
For use with OS60JS30 & OS100JS30									
1, 3R, 12	IP65	Black	3.1/80	OFF/ON	Yes	Yes	0.30	OHB80J6	90
1, 3R, 12	IP65	Red/Yel	3.1/80	OFF/ON	Yes	Yes	0.30	OHY80J6	
For use with OES200J3-S & OES400J3-S									
1, 3R, 12	IP65	Black	4.9/145	OFF/ON	Yes	Yes	0.39	OHB145J12	80
1, 3R, 12	IP65	Red/Yel	4.9/145	OFF/ON	Yes	Yes	0.39	OHY145J12	
1, 3R, 12	IP65	Metal	4.9/145	OFF/ON	No	Yes	1.50	OETL-ZX74	190

Shafts

For use with:	Length (inches/mm)	Description	Weight (lbs.)	Catalog number	List price
OS30AJS30 & OS30ACCS30	6.7/170	0.20 x 0.20" (5 x 5mm)	0.08	OXP5X170	\$ 16
OS60JS30 & OS100JS30	6.7/170	0.24 x 0.24" (6 x 6mm)	0.08	OXP6X210	16
OES200J3-S & OES400J3-S	12.8/325	0.47 x 0.47" (12 x 12mm)	0.90	OXP12X325	40

Terminal lug kit

For use on:	Wire size	Kit weight (lbs)	Wire type	Lugs per kit	Catalog number	List price
OS30AJS30 & OS30ACCS30	#18 – 8	—	Cu	—	Integral	—
	#14 – 4	—	Cu	—	Integral	—
OS60JS30	#14 – 2/0	0.43	Cu/Al	6	OZXA-24	\$ 24
OES200J3-S	#6 – 300 kcmil	0.93	Cu/Al	6	OZXA-25	80
OES400J3-S	#2 – 600 kcmil	3.50	Cu/Al	6	OZXA-26	190

① J type fuse clips are standard. If 600V Type "T" fuse clips are desired, please order the "T" type fuse adapter kit.

Other configurations

Flange operated

30A – 100A, UL fuse class J,CC,T

Disconnect
switches
Fusible

For a complete assembly,
please select one of each:

- 1 switch
- 1 handle
- 1 shaft
- 1 terminal lug

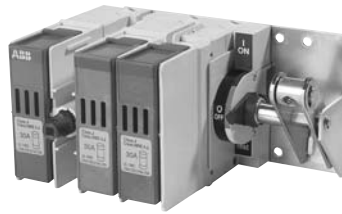

OS30AJ30-F



DSFHS-12

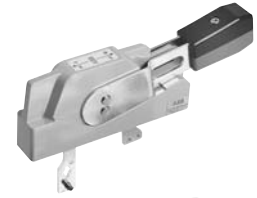

DSFHN-HS12



DSFHN-HS_

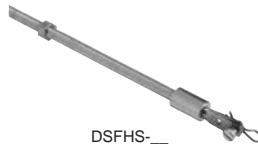
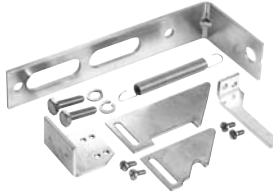

DSFHS_



OZXA-24

UL Listed
CSA Approved
IEC Rated
CE Marked

Flange operated switches — 3 pole

UL general purpose amp rating	UL fuse type 600V	Maximum horsepower rating					Weight (lbs)	Catalog number	List price
		Three phase							
		200V	208V	240V	480V	600V			
30	J	5	7.5	7.5	15	20	2.20	OS30AJF30	\$ 500
30	CC	5	7.5	7.5	15	20	2.50	OS30ACCF30	500
60	J	15	15	15	30	50	3.52	OS60JF30	590
100	J ^①	25	25	30	60	75	3.97	OS100JF30	690
200 ^②									

Handles

UL/NEMA type	Color	Length inches/mm	Marking	Defeat- able	Padlock- able	Weight (lbs)	Catalog number	List price
1, 3R, 12	Metal	6.9/175	O/I & OFF/ON	Yes	Yes	3.52	DSFHN-HS12	\$ 156
4, 4X	Metal	6.9/175	O/I & OFF/ON	Yes	Yes	3.52	DSFHN-HS4	240

Shafts

Shaft length inches	Weight (lbs)	Catalog number	List price
12	0.39	DSFHS-12	\$ 28
17	0.55	DSFHS-17	40
22.5	0.73	DSFHS-22	52

Terminal lug kit

For use on:	Wire size	Kit weight (lbs)	Wire type	Lugs per kit	Catalog number	List price
OS30_	#18 – #8	—	Cu	—	Standard	—
OS60_	#14 – #4	—	Cu	—	Standard	—
OS100_	#14 – 2/0	0.43	Cu/Al	6	OZXA-24	\$ 24

Door hardware kits — NEMA 12

Item	Weight (lbs)	Catalog number	List price
Safety door latch, 2 point doors less than 40" high	2.0	KDH2R	\$ 200
Safety door latch 3 point doors greater than 40" high	2.5	KDH3R	225

① J type fuse clips are standard. If 600V Type "T" fuse clips are desired, please order the "T" type fuse adapter kit.

② 200A available by using a non-fusible 200A switch and a trailing fuse block. Please consult factory.

③ Discount schedule SA

Other configurations

Global concept disconnect switches 30A – 60A

For a complete assembly,
please select one of each:

- 1 fusible disconnect body
- 1 set of fuse carriers
- 1 shaft
- 1 handle



About the global concept ...

Customers in Boston and Berlin?

Do your customers in Boston prefer UL Class J fuses and your customers in Berlin specify DIN standard fuses? No problem!

ABB Global concept fusible disconnect switches offer the flexibility to design a panel using a common disconnect

body. When the panel destination is known, simply insert the appropriate fuse carrier.

Global concept = common disconnect body + an assortment of fuse carriers.

High volumes with various fuse types — Global concept.

Fusible disconnect bodies — 30A & 60A

UL general purpose amp rating	IEC AC21 amp rating	Description	Technical ratings	Weight (lbs)	Catalog number	List price
30	32	3 pole	See pages 17.107 – 17.110	1.40	OS32M12	\$ 130
		4 pole		1.70	OS32M22F	150
		3 pole + neutral		1.70	OS32M22N1①	200
		3 pole, side operation		1.40	OS32MS30	210
		4 pole, side operation		1.70	OS32MS40F	270
		3 pole + neutral, side operation		1.70	OS32MS40N1①	320
60	63	3 pole	See pages 17.107 – 17.110	2.40	OS63X12	\$ 230
		4 pole		2.80	OS63X22F	290
		3 pole + neutral		2.80	OS63X22N1①	340
		3 pole, side operation		2.40	OS63XS30	390
		4 pole, side operation		2.80	OS63XS40F	450
		3 pole + neutral, side operation		2.80	OS63XS40N1①	500

Fuse carriers for 3 pole units and units with neutral ②

For use on:	Fuse type	Technical ratings	Weight (lbs)	Catalog number	List price
OS32M_	UL J 30A UL CC 30A DIN Neozed D01 DIN Neozed D02 NFC 10x38 NFC 14x51 BS88 A1 BS88 A2 BS88 E1 BS88 F1	See pages 17.107 – 17.110	0.48	OSC30AJ3 OSC30ACC3 OSC16D301 OSC35D302 OSC25F310 OSC32F314 OSC32B3A1 OSC32B3A2 OSC32B3E1 OSC32B3F1	\$ 150
OS63X_	UL J 60A NFC 14x51 NFC 22x58 BS88 A2, A3 CSA C30, C60 DIN 000, 00	See pages 17.107 – 17.110	0.60	OSC60J3 OSC50F3 OSC63F3 OSC63B3 OSC63D3	

Fuse carriers for 4 pole units ③

For use on:	Fuse type	Technical ratings	Weight (lbs)	Catalog number	List price
OS32M_	UL J 30A UL CC 30A DIN Neozed D01 DIN Neozed D02 NFC 10x38 NFC 14x51 BS88 A1 BS88 A2 BS88 E1 BS88 F1	See pages 17.107 – 17.110	0.64	OSC30AJ4 OSC30ACC4 OSC16D401 OSC35D402 OSC25F410 OSC32F414 OSC32B4A1 OSC32B4A2 OSC32B4E1 OSC32B4F1	\$ 200
OS63X_	UL J 60A NFC 14x51 NFC 22x58 BS88 A2, A3 CSA C30, C60 DIN 000, 00	See pages 17.107 – 17.110	0.80	OSC60J4 OSC50F4 OSC63F4 OSC63B4 OSC63D4	

NOTE: Handles and shafts — see pages 17.83 – 17.84 for OS32_ and page 17.87 for OS63_.

① N1-versions will be delivered with neutral carrier.

② Part number includes 3 pieces of fuse carriers.

③ Part number includes 4 pieces of fuse carriers.

Other configurations

High speed fuse pattern

Special type fuses

Disconnect
switches
Fusible

For a complete assembly,
please select one of each:

- 1 switch body
- 1 adapter kit
- 1 shaft
- 1 handle

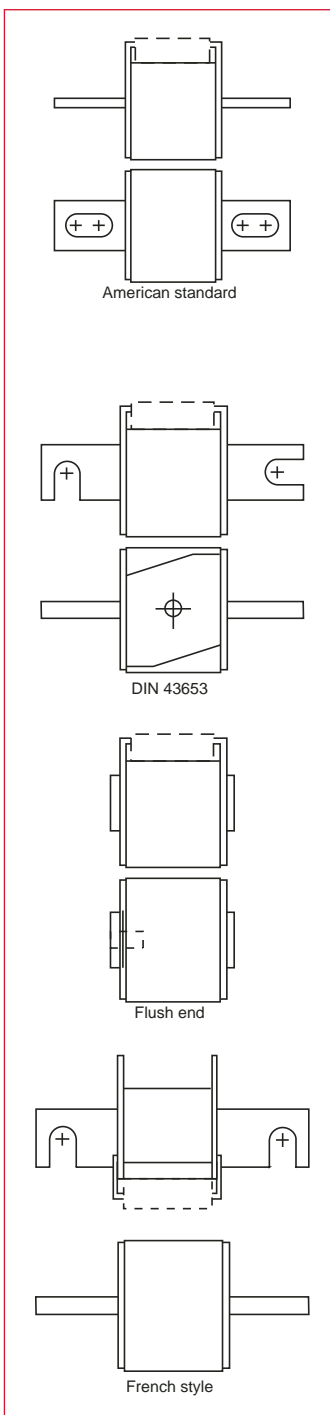
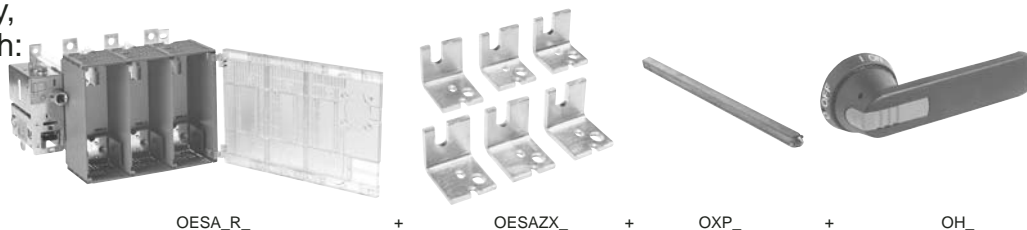

Selecting switch bodies and adapter kits

Please select switch body and adapter kit according to your fuses. Switch body alone can not be used — an adapter kit is always needed.

Switch bodies — 200A through 800A

UL general purpose amp rating	Maximum horsepower rating				Max. allowed fuse power dissipation at rated current	Weight (lbs)	Catalog number	List price
	Three phase							
	208V	240V	480V	600V				
3 pole								
200	50	60	125	150	22W	15.21	OES200R03	\$ 1220
400	125	125	250	350	45W	17.20	OES400R03	1740
600	150	200	400	500	60W	37.48	OES600R03	2640
800	200	250	500	600	65W	37.48	OES800R03	4590
4 pole								
200	50	60	125	150	22W	17.4	OES200R04	1510
400	125	125	250	350	45W	19.4	OES400R04	2140
600	150	200	400	500	60W	46.3	OES600R04	3270
800	200	250	500	600	65W	46.3	OES800R04	5710

Fuse adapter kits — for switches OES200 – OES400

Fuse standard	For 3 pole switch		For 4 pole switch	
	Catalog number	List price	Catalog number	List price
American standard	OESAZX1-S4 OESAZX1-S5	\$ 220	OESAZX1-S4/4 OESAZX1-S5/4	\$ 290
DIN80 (DIN43653) DIN80 sizes 00 and 000 (DIN 43653) DIN110 (DIN43653) DIN140 (DIN43653)	OESAZX1-S7 OESAZX1-S9 OESAZX1-S2 OESAZX1-S6		OESAZX1-S7/4 OESAZX1-S9/4 OESAZX1-S2/4 OESAZX1-S6/4	
Flush-end, 70mm body Flush-end, 50mm body	OESAZX1-S8 OESAZX1-S3		OESAZX1-S8/4 OESAZX1-S3/4	
French French with micro switches	OESAZX1-S10 OESAZX1-S11		OESAZX1-S10/4 OESAZX1-S11/4	

Fuse adapter kits — for switches OES600 – OES800

Fuse standard	For 3 pole switch		For 4 pole switch	
	Catalog number	List price	Catalog number	List price
American standard DIN80, DIN 110, DIN 140 (DIN43653) Flush-end, 50mm and 70mm body French French with micro switches	OESAZX2-S4 OESAZX2-S2 OESAZX2-S3 OESAZX2-S5 OESAZX2-S6	\$ 400	OESAZX2-S4/4 OESAZX2-S2/4 OESAZX2-S3/4 OESAZX2-S5/4 OESAZX2-S6/4	\$ 530

Handles and shafts — see pages 17.91 – 17.92.

Selecting the right fusible disconnect for HSF fuses may be difficult. Due to UL restrictions it is not possible to give a general fuse selection table for your use. Therefore we ask you to contact ABB Inc., Wichita Falls, in application issues. Information needed is nominal current of the application and catalog number of the fuse.

Other configurations

High speed fuse pattern

Standard switches

For a complete assembly, please select one switch catalog number which includes:

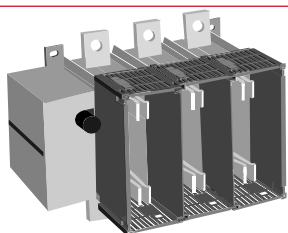

Switch body



shaft



handle

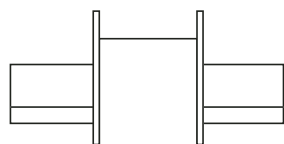

DIN 43620

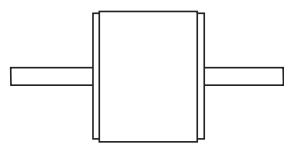

NFC Style

Selecting switch bodies

There are some HSF fuses that fit in standard pattern fusible disconnects, no adapter kits needed.

DIN-style fusible disconnects — 32A through 800A^①

UL general purpose amp rating	AC23A rated operational power in kW				Fuse type	Weight (lbs.)	Catalog number	List price
	230V	400V	500V	690V				
3 pole								
30	9	15	22	30	DIN 000, 00	2.9	OS32RD12	\$ 500
60	18.5	30	37	60	DIN 000, 00	2.9	OS63RD12	500
100	45	80	110	132	DIN 000, 00	3.3	OS160RD03	700
100	45	80	110	132	DIN 43653: 000/80	3.3	OS160RD0380	700
200	70	132	170	230	DIN 0, 1	16.1	OESA250RD3	1380
400	110	210	280	330	DIN 0, 1, 2	18.3	OESA400RD3	1860
600	180	315	400	540	DIN 3	35.2	OESA630RD3	2900
800	200	350	470	600	DIN 3	39.6	OESA800RD3	4760
4 pole								
30	9	15	22	30	DIN 000, 00	3.5	OS32RD22	660
60	18.5	30	37	60	DIN 000, 00	3.5	OS63RD22	660
100	45	80	110	132	DIN 000, 00	4.0	OS160RD04	930
100	45	80	110	132	DIN 43653: 000/80	4.0	OS160RD0480	930
200	70	132	170	230	DIN 0, 1	18.1	OESA250RD4	1840
400	110	210	280	330	DIN 0, 1, 2	20.7	OESA400RD4	2480
600	180	315	400	540	DIN 3	46.3	OESA630RD4	3860
800	200	350	470	600	DIN 3	52.9	OESA800RD4	6340

NFC-style fusible disconnects — 25A through 125A^②

UL general purpose amp rating	AC23A rated operational power in kW				Fuse type	Weight (lbs.)	Catalog number	List price
	230V	400V	500V	690V				
3 pole								
30	6	11	14	22	NFC 10x38	1.54	OS25RF1210	\$ 400
30	8	14	18	25	NFC 14x51	1.54	OS32RF1214	400
60	18.5	30	37	60	NFC 14x51	2.90	OS63RF1214	500
100	37	60	80	110	NFC 22x58	3.30	OS125RF0322	700
100	45	80	110	132	NFC 27x60	3.30	OS160RF0327	700
4 pole								
30	6	11	14	22	NFC 10x38	2.00	OS25RF2210	530
30	8	14	18	25	NFC 14x51	2.00	OS32RF2214	530
60	18.5	30	37	60	NFC 14x51	3.50	OS63RF2214	660
100	37	60	80	110	NFC 22x58	4.00	OS125RF0422	930
100	45	80	110	132	NFC 27x60	4.00	OS160RF0427	930

Selecting the right fusible disconnect for HSF fuses may be difficult. Due to UL restrictions it is not possible to give a general fuse selection table for your use. Therefore we ask you to contact ABB Control Inc., Wichita Falls, regarding application issues.

^① OS32 – OS160 include handle OHB65J6 and shaft OXP6X161.
OESA250 – OESA400 include handle OHB125J12 and shaft OXP12X250.
OESA630 – OESA800 include handle OHB145J12 and shaft OXP12X250.
^② OS25 – OS32 include handle OHB65J5 and shaft OXP5X150.
OS50 – OS125 include handle OHB65J6 and shaft OXP6X161.

Other configurations

BS fuse pattern ①

20A – 800A

Disconnect
switches
Fusible

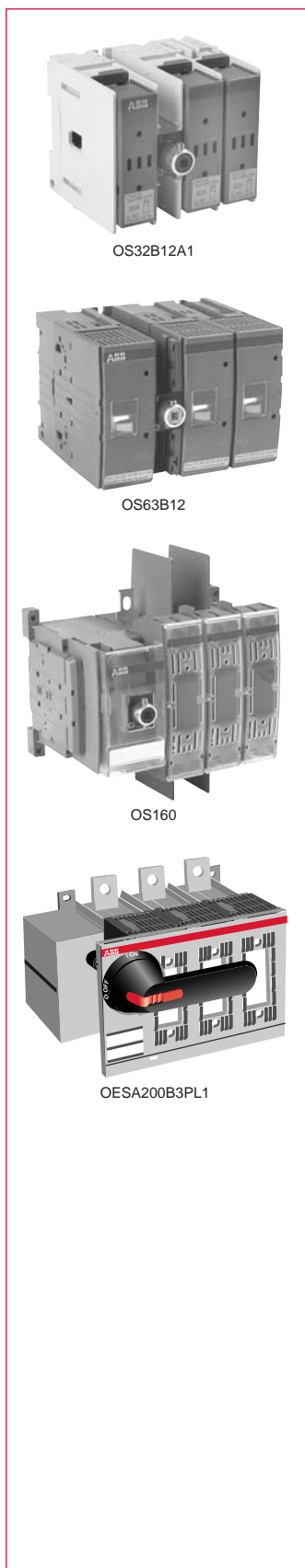

BS fuse pattern switches (20A – 32A)

Handle and shaft included

Catalog number	Number of poles	Rated op. current/ Rated op. power		Fuse type and size	Fuse standard
		415V	690V		
OS20B12A1 OS20B22A1N1 OS20B22A1F	3 3 + non-fused neutral 4	20 A 10 kW	20A 15 kW	A1 20 A	BS 88-2 IEC 269-2-1
OS32B12A1 OS32B22A1N1 OS32B22A1F	3 3 + non-fused neutral 4	32 A 15 kW	32A 25 kW	A1 32 A	
OS32B12A2 OS32B22A2N1	3 3 + non-fused neutral	32 A 15 kW	32A 25 kW	A2 32 A	
OS32B12F1 OS32B22F1N1	3 3 + non-fused neutral	32 A 15 kW	32A 25 kW	F1 32 A	BS 88-6

BS pattern switches (32A – 800A)

Handle and shaft included
Fuse covers included for 200A – 800A

Catalog number	Number of poles	Rated operational voltage AC23[V]	I _m (open) [A]	Rated operational current/ Rated operational power in category AC23A, IEC947 [A/kW]					Weight with package [kg]
				230V	400V	415V	500V	690V	
OS32B12 OS32B22N1	3 4②	500	32	32/7.5	32/11	32/15	32/15	—	1.3 1.6
OS63B12 OS63B22N1	3 4②	690	63	63/15	63/30	63/30	63/30	401/30	1.3 1.6
OS100B12 OS100B13 OS100B01 OS100B11	3 4② 1 2	690	125	100/30	100/55	100/55	100/70	501/45	1.5 1.8 0.9 1.9
OS160B12 OS160B13 OS160B01 OS160B11	3 4 1 2	690	160	100/30	100/55	100/55	100/70	50③/45	1.5 1.8 0.9 1.2
OESA200B3PL1 OESA200B4PL1 OESA200B1PL1 OESA200B2PL1	3 4② 1 2	690	200	200/57	200/100	200/110	200/140	200/180	7.1 8.2 5.1 6.1
OESA250B3PL1 OESA250B4PL1	3 4②	690	250	250/70	250/132	250/140	250/170	250/230	7.1 8.2
OESA315B3PL1 OESA315B4PL1 OESA315B1PL1 OESA315B2PL1	3 4② 1 2	690	315	315/90	315/100	315/100	315/220	315/290	7.9 8.9 5.9 6.9
OESA400B3PL1 OESA400B4PL1 OESA400B1PL1 OESA400B2PL1	3 4② 1 2	690	400	400/110	400/210	400/230	400/280	400/330	8.3 9.4 6.3 7.3
OESA630B3PL1 OESA630B4PL1 OESA630B1PL1 OESA630B2PL1	3 4② 1 2	690	630	630/180	630/315	630/340	630/400	630/540	16.0 21.0 6.5 11.0
OESA800B3PL1 OESA800B4PL1 OESA800B1PL1 OESA800B2PL1	3 4② 1 2	690	800	800/200	800/350	800/380	720/470	720/600	18.0 24.0 6.7 12.3



BS fuses are widely used in UK, South-Africa, Australia and Hong Kong

① Please consult factory for additional information.
② The fourth pole is provided with a solid link which can be replaced with a fuse.

Other configurations

DIN fuse pattern^①

32A – 800A

DIN pattern switches (32A – 800A)

Handle and shaft included



OS63D12

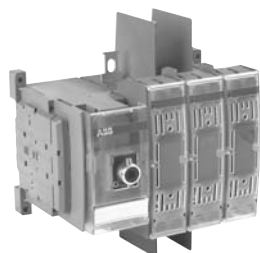

OS160

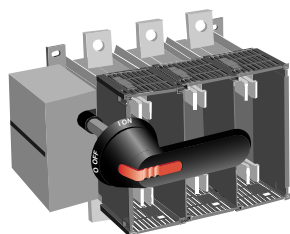

OESA250P3PL

Rated Catalog number voltage	Number of poles	operational AC23[V]	I _{th} (open) [A]	Rated operational current/ Rated operational power in category AC23A, IEC947 [A/kW]					Weight with package [kg]
				230V	400V	415V	550V	690V	
OS32D12 OS32D22N1 OS32D22F	3 3 + non-fused neutral 4	690	32	32/7.5	32/11	32/15	32/15	—	1.3 1.6 1.6
OS63D12 OS63D22N1 OS63D22F	3 3 + non-fused neutral 4	690	63	63/15	63/30	63/30	63/30	40/30	1.3 1.6 1.6
OS125D12 OS125D22N1 OS125D22F OS125D01 OS125D11	3 3 + non-fused neutral 4 1 2	690	125	100/30	100/55	100/55	100/70	50/45	1.5 1.8 1.8 0.9 1.2
OS160D12 OS160D22N1 OS160D22F OS160D01 OS160D11	3 3 + non-fused neutral 4 1 2	690	160	100/30	100/55	100/55	100/70	50/45	1.5 1.8 1.8 0.9 1.2
OESA250D3PL OESA250D4PL OESA250DF4PL OESA250D1PL OESA250D2PL	3 3 + non-fused neutral 4 1 2	690	250	250/70	250/132	250/140	250/170	250/230	7.3 8.2 8.2 5.5 6.4
OESA400D3PL OESA400D4PL OESA400DF4PL OESA400D1PL OESA400D2PL	3 3 + non-fused neutral 4 1 2	690	400	400/110	400/210	400/230	400/280	400/330	8.3 9.4 9.4 6.3 7.3
OESA630D3PL OESA630D4PL OESA630DF4PL OESA630D1PL OESA630D2PL	3 3 + non-fused neutral 4 1 2	690	630	630/180	630/315	630/340	630/400	630/540	16.0 21.0 21.0 6.5 11.0
OESA800D3PL OESA800D4PL OESA800DF4PL OESA800D1PL OESA800D2PL	3 3 + non-fused neutral 4 1 2	690	800	800/200	800/350	800/380	720/470	720/600	18.0 24.0 24.0 8.5 13.0



DIN fuses are mainly used in continental Europe (excluding France below 125A), Asia, Africa and South-America

^① Please consult factory for additional information.

Other configurations

NFC fuse pattern

63A – 125A, 14x51 & 22x58

Disconnect
switches
Fusible



OS32F1214



OS63F12

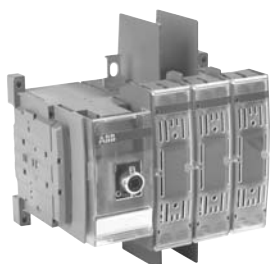

OS125F03

NFC fuse pattern switches (cylinder) (10x38) (14x51)

Handle and shaft included

Catalog number	Number of poles	Rated op. current/ Rated op. power		Fuse type and size	Fuse standard
		415V	690V		
OS25F1210 OS25F2210N1 OS25F2210F	3 3 + non-fused neutral 4	25 A 12 kW	25A 22 kW	10 x 38 25 A	IEC 269-2-1
OS32F1214 OS32F2214N1 OS32F2214F	3 3 + non-fused neutral 4	32 A 15 kW	32A 25 kW	14 x 51 32 A	IEC 269-2-1

NFC fuse pattern (cylinder fuse links), (14x51 & 22x58)

Handle and shaft included

Catalog number	Number of poles	Rated operational voltage AC23[V]	I _{th} (open) [A]	Rated operational power in category AC23A, IEC947 [A/kW]					Weight with package [kg]
				230V	400V	415V	550V	690V	
OS50F12	3	690	50	50/15	50/25	50/25	50/33	50/45	1.3
OS50F22F	4	690	50	50/15	50/25	50/25	50/33	50/45	1.6
OS63F12	3	690	63	63/18.5	63/30	63/30	63/37	63/60	1.3
OS63F22F	4	690	63	63/18.5	63/30	63/30	63/37	63/60	1.6
OS100F03	3	690	125	100/30	100/45	100/55	100/60	100/90	2.2
OS100F04F	4								2.8
OS100F04N1	3 + non-fuse N								2.8
OS125F03	3	690	125	125/37	125/60	125/60	125/80	125/110	1.3
OS125F04F	4								1.6
OS125F04N1	3 + non-fuse N	690							1.6



NFC fuses are used in France and in French speaking Africa

① Please consult factory for additional information.

Fuse monitors



OFM_

Fuse monitors

Rated voltage	Weight (lbs.)	Catalog number	List price
100 - 240	0.31	OFM240	\$ 290
380 - 600	0.31	OFM600	

Suitable for 3 phase circuits. Includes 1 N.O. & 1 N.C. auxiliary contacts and red & green LED lights.

Mounting accessories

For switch size	Crimp terminal size (mm)	Catalog number	List price
OS30 - 100	2.8 - 0.8	OFMZX2	\$ 20
OES200 - 800	6.3 - 0.8	OFMZX4	70

Includes 6 crimp terminals.

Description

- Indicates single phasing
- Operates with all fuse types
- No need for external supply voltage
- Wide voltage range, 100-240VAC and 380-600VAC
- UL Listed, EMC tested
- Fuse monitor is automatically reset after the blown fuses have been replaced
- One trip contact, one alarm contact and two LEDs (red and green)
- Phase imbalance immune
- Compact size
- Snap-on and screw-on mounting for OS disconnects
- Suitable to be used as a standalone device

Motor operators^① for 200A – 800A

Disconnect
switches
Fusible

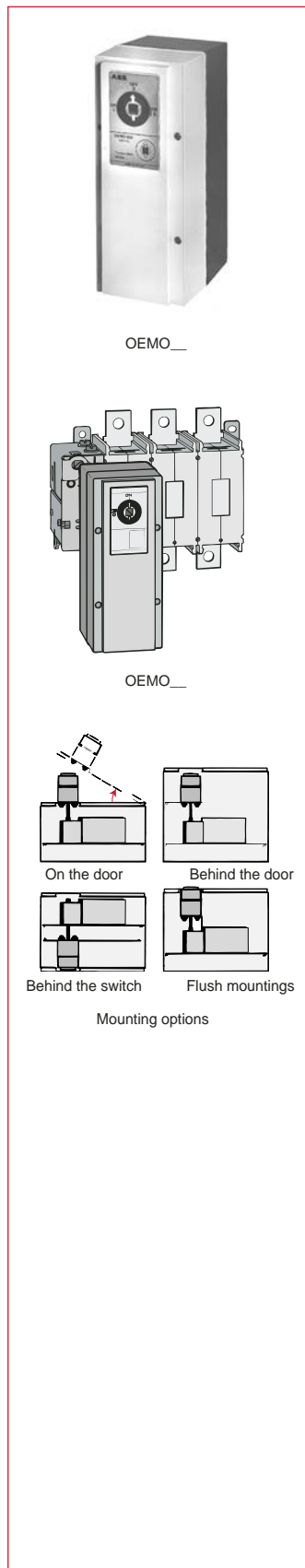

Motor operators^① — 2 position, I/O, ON/OFF

For use on:	Voltage	Weight (lbs.)	Catalog number	List price
OES200 – OES400	24 VDC/AC 48 VDC/AC 110 VAC 220 VAC 220 VDC 230 VAC 240 VAC	14.0	OEMO002/24VDCAC OEMO002/48VDCAC OEMO002/110VAC OEMO002/220VAC OEMO002/220VDC OEMO002/230VAC OEMO002/240VAC	\$ 6514
OES600 – OES800	24 VDC/AC 48 VDC/AC 110 VAC 110 VDC 220 VAC 220 VDC 230 VAC 240 VAC	14.0	OEMO003/24VDCAC OEMO003/48VDCAC OEMO003/110VAC OEMO003/110VDC OEMO003/220VAC OEMO003/220VDC OEMO003/230VAC OEMO003/240VAC	7644

Motor operators^① — 3 position, I/O/II

For use on:	Voltage	Weight (lbs.)	Catalog number	List price
110 VAC OES200 – OES400	24 VDC/AC 48 VDC/AC 14.0 220 VAC 220 VDC 240 VAC		OEMO202/24VDCAC OEMO202/48VDCAC OEMO202/110VAC OEMO202/220VAC OEMO202/220VDC OEMO202/240VAC	\$ 7644
OES600 – OES800	24 VDC/AC 48 VDC/AC 110 VAC 220 VAC 240 VAC	14.0	OEMO303/24VDCAC OEMO303/48VDCAC OEMO303/110VAC OEMO303/220VAC OEMO303/240VAC	9490

OEMO 202_ – 303_ motor operators require a transfer mechanism.

Mounting kit for OEMO motor operator

For use on:	Package (pcs.)	Catalog number	List price
OES200 – OES400 OES600 – OES800	1 1	OEMOZX1 OEMOZX2	\$ 400

① Not UL listed

