

Components

Contact blocks & holders

Operator mounted

Operator mounted contacts

All CBK contact blocks, lamp modules and transformers can be used with CBK 22mm and CBG 30mm operators.

Contact blocks are color coded to easily identify the contact configuration:

- Green — Normally Open (N.O.) contacts
- Red — Normally Closed (N.C.) contacts

In addition, they snap-on to the operator for time saving installation







Single operator mounted contact block

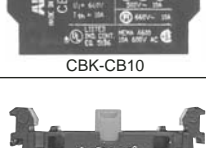

Double operator mounted contact block

Contact blocks — operator mounted

Item	Contact configuration	Catalog number	List price	
8 Single contact blocks				
 CBK-CB10	1 N.O. 1 N.C.	CBK-CB10 CBK-CB01	\$ 8.00	
	Gold plated low energy contacts, 24VAC, 5mA			
 CBK-CB10G	1 N.O. 1 N.C.	CBK-CB10G CBK-CB01G	16.00	
	Flat pin connections			
 CBK-CB10FP	1 N.O. 1 N.C.	CBK-CB10FP CBK-CB01FP	11.00	
	Dummy block	CBK-XBB	2.00	
 KCB-20 ①	2 N.O.	KCB-20	16.00	
	 KCB-02 ①	2 N.C.		KCB-02
		 KCB-11 ①		1 N.O. - 1 N.C.

Contact block holder

Item	Catalog number	List price
 CBK-H5	CBK-H5	\$ 4.00
 CBK-AB	CBK-CH	2.00

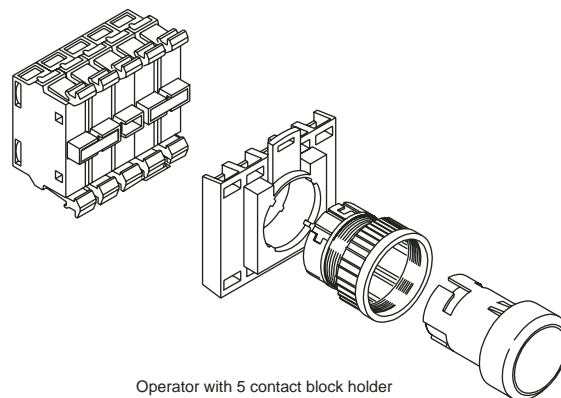

Operator with 5 contact block holder

① For gold plated low energy contacts, 24 VAC, 5 mA, consult factory.