





# Components

## Lamp modules & transformers

Pilot Devices  
Type CBG 30mm







### Lamp modules & transformers — operator mounted

Item	Voltage	Catalog number	List price
 CBK-LMF	<b>Lamp module</b>		
	<b>Full voltage type</b>	CBK-LMF	\$ 17.50
 CBK-LMR1	<b>Resistor type</b>		
	120V/60V 240V/120V 24V <sup>①</sup> 120V/24V <sup>②</sup>	CBK-LMR1 CBK-LMR2 CBK-LMR24 CBK-LMLED	21.50
 CBK-LMT1	<b>Lamp module transformer</b>		
	120V/6V 240V/6V 380V/6V 480V/6V 120V/24V 240V/24V 380V/24V 480V/24V	CBK-LMT1 CBK-LMT2 CBK-LMT3 CBK-LMT4 CBK-LMT124 CBK-LMT224 CBK-LMT324 CBK-LMT424	35.00
 CBK-LT1	<b>Illuminated pushbutton transformer</b> <sup>④</sup>		
	120V/6V 240V/6V 380V/6V 480V/6V 120V/24V 240V/24V 380V/24V 480V/24V	CBK-LT1 CBK-LT2 CBK-LT3 CBK-LT4 CBK-LT124 CBK-LT224 CBK-LT324 CBK-LT424	35.00

### Lamp modules & transformers — base mounted

Item	Voltage	Catalog number	List price
 CBK-LMFB	<b>Full voltage type</b>	CBK-LMFB	\$ 17.50
	<b>Resistor type</b> 120V/60V 240V/120V	CBK-LMRB1 CBK-LMRB2	21.50

### Lamp bulbs

Item	Voltage	Catalog number	List price
 CBK-LB6	<b>Filament</b>		
	6 VAC/DC 12 VAC/DC 24 VAC/DC 30 VAC/DC 48 VAC/DC 60 VAC/DC 130 VAC/DC	CBK-LB6 CBK-LB12 CBK-LB24 CBK-LB30 CBK-LB48 CBK-LB60 CBK-LB1	\$ 6
 CBK-LBN1	<b>Neon</b> <sup>③</sup>		
	220 VAC	CBK-LBN2	
 CBK-LBD1R	<b>LED bulbs</b>		
	<b>Standard</b>		
 CBK-LBD1R	<b>Red</b>		
	12 VDC	CBK-LBD12R	27
	24 VAC/DC	CBK-LBD8R	15
	48 VAC/VDC	CBK-LBD48R	21
	60VAC/VDC	CBK-LBD60R	21
	110-130 VAC/DC	CBK-LBD13R	21
	120 VAC	CBK-LBD1R	15
	230 VAC	CBK-LBD2R	21
	<b>Green</b>		
	12 VDC	CBK-LBD12G	27
24 VAC/DC	CBK-LBD8G	15	
48 VAC/VDC	CBK-LBD48G	21	
60VAC/VDC	CBK-LBD60G	21	
110-130 VAC/DC	CBK-LBD13G	21	
120 VAC	CBK-LBD1G	15	
230 VAC	CBK-LBD2G	21	
 CBK-LBD1R	<b>Yellow</b>		
	12 VDC	CBK-LBD12Y	27
	24 VAC/DC	CBK-LBD8Y	15
	48 VAC/VDC	CBK-LBD48Y	21
	60VAC/VDC	CBK-LBD60Y	21
	110-130 VAC/DC	CBK-LBD13Y	21
	120 VAC	CBK-LBD1Y	15
	230 VAC	CBK-LBD2Y	21
	<b>Blue</b>		
	12 VDC	CBK-LBD12L	32
24 VAC/DC	CBK-LBD8L	18	
48 VAC/VDC	CBK-LBD48L	21	
60VAC/VDC	CBK-LBD60L	21	
110-130 VAC/DC	CBK-LBD13L	28	
120 VAC	CBK-LBD1L	18	
230 VAC	CBK-LBD2L	24	
 CBK-LBD1R	<b>White</b>		
	12 VDC	CBK-LBD12W	32
	24 VAC/DC	CBK-LBD8W	18
	48 VAC/VDC	CBK-LBD48W	21
	60VAC/VDC	CBK-LBD60W	21
	110-130 VAC/DC	CBK-LBD13W	28
120 VAC	CBK-LBD1W	18	
230 VAC	CBK-LBD2W	24	
 CBK-LBD1R	<b>Flashing</b>		
	Red 24 VDC	CBK-LBDRF	20
	Green 24 VDC	CBK-LBDGF	
Yellow 24 VDC	CBK-LBDYF		

### Diode block

Item	Voltage	Catalog number	List price
 CBK-CBD	250V, 1A	CBK-CBD	\$ 14.00

### Diagram for lamp test

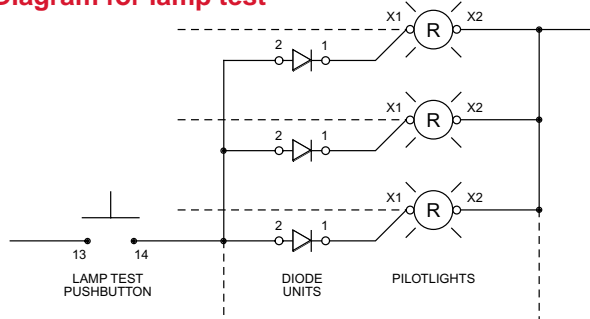

WHEN SEVERAL PILOT LIGHTS ARE CONNECTED TO A COMMON LAMP TEST BUTTON, CONNECT A DIODE TO EACH PUSHBUTTON AS SHOWN. A SPECIAL DIODE BLOCK IS AVAILABLE FOR THIS PURPOSE.

- ① Designed for electronic circuits. The resistor limits the making current and prevents disturbances in the circuit. 24V filament bulb required.
- ② Designed for LED 24V bulbs.
- ③ Use with red, yellow and clear lenses only.
- ④ Mounts on to CBK-LMF.