

General information

Implementation

30mm & 40mm, IP65, UL Type 4

Plastic
Limit switches

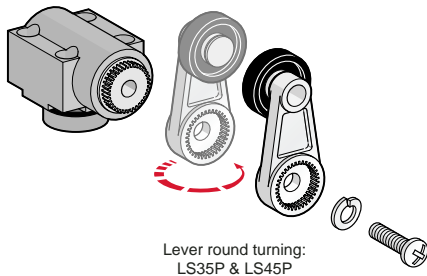

Lever round turning:
LS35P & LS45P

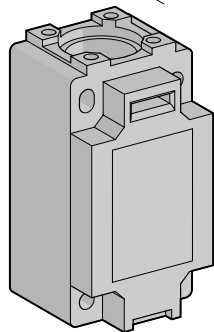
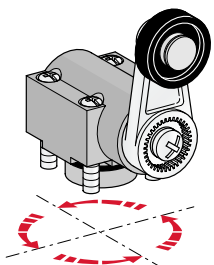

Head orientation:
LS35P & LS45P

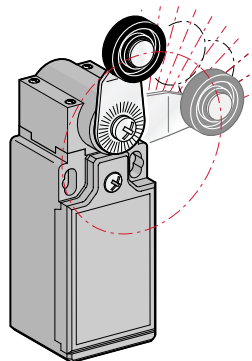

Free position adjustment
10 in 10° of lever:
LS35P

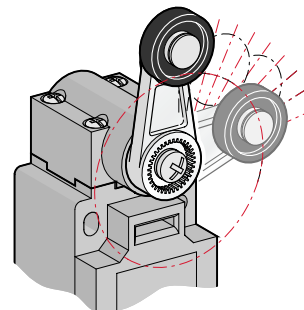

Free position adjustment
9 in 9° of lever:
LS45P

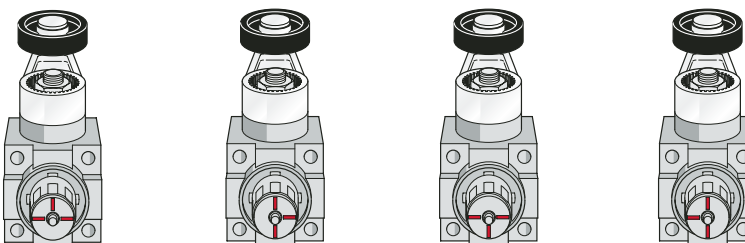
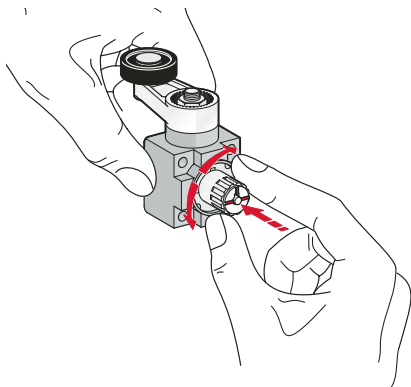

Operating mode selection only, LS45P

9