

# Type OM, ON, & OL Cam switches

## ABB Cam switches

### Cam switches OM, ON & OL (10A, 25A, 40A, 80A, 125A, 160A & 200A)

Complete range of standard and special cam switches for door and base mounting

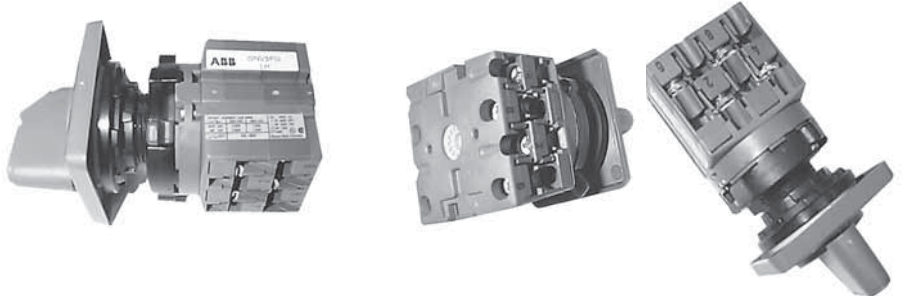

Complete delivery includes handle and frontplate. Snap-on mounting of contact block with interlocking

Protected terminals and interconnections. Selflifting plus-minus screws for fast assembly.

Handle, color black or grey. Padlockable handle, color black or red-yellow.



Keylock and cylinder lock solutions

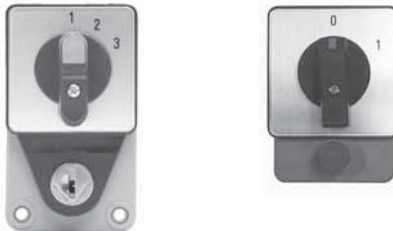

Enclosed cam switches. Water and dustproof IP 65. NEMA4 X for outdoor use.



## Door mounting cam switches

- IP 65
- NEMA 4X outdoor (ON, OL40)
- Key operated switch, IP54
- OM, Miniature
- ON, Normal
- OL, Large

### Door drilling

OM: Ø 16.5mm / Ø 22.5mm  
 ON: Ø 22.5mm / Ø 30.5mm  
 OL40: Ø 22.5mm / Ø 30.5mm

Maximum panel thickness 5.5 mm.

The black handle with square escutcheon plate marked for switch type is supplied with the switch body. Optional adaptor ring available for 30.5 mm hole.

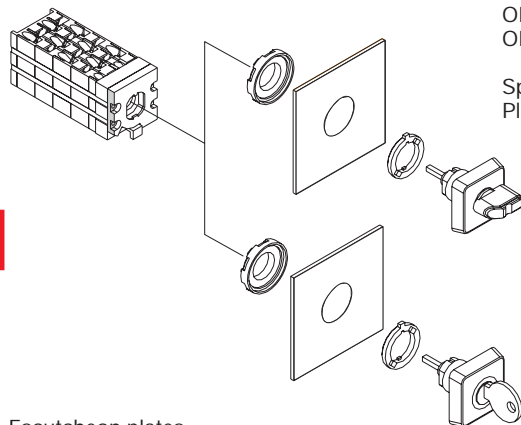

### Escutcheon plates

OM	30x30
ON	48x48
OL40	48x68

## DIN-rail mounting

- P 44
- ON, Modular



### Number of contacts

OM:	16 contacts
ON:	20 contacts
ON_M:	6 contacts
OL40:	20 contacts
OL80, 125, 160, 200:	24 contacts

Special switches up to 60 contacts  
 Please consult with us.

## Features:

- Complete delivery for easy purchasing and assembly
  - Standard delivery with black handle, alt. grey or red yellow handle
  - Small panel size: front space in side to side mounting 30 mm or 50 mm up to 25 A
  - Finger protected terminals and interconnections (IP20, VBG4)
  - Self lifting screws, terminal screws for fast cabling
  - Double break silver contacts with 0,35 µm gold grid ensure a high breaking capacity and reliable connection.
- Also available with solid golden contacts for extremely difficult circumstances. Have to be ordered separately, please add G to the type, e.g: OMA 1 PBG.
- Fast special engraving service available
  - Metallic shaft as special version
  - Fast-on terminals available as special version

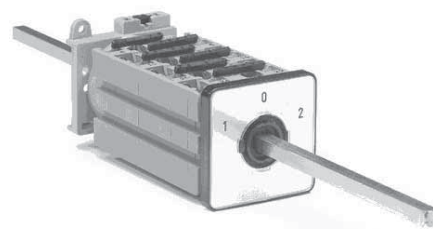

## User guiding CamWeb Configurator for special cam switches

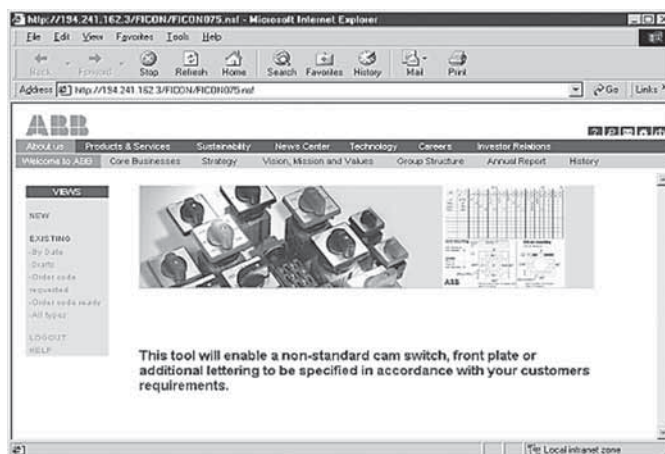

The user guiding CamWeb Configurator generates automatically the new cam switch type and sends order code for non-standard cam switches and front plates.

The global order code enables fast and failure free EDI-orders as standard switch from the first time.

The path to the configurator through ABB home pages:  
[www.abb.com](http://www.abb.com) or [inside.abb.com](http://inside.abb.com)  
 Product&Services  
 Low Voltage Products  
 Switches&Fusegear  
 Switches  
 Cam Switches – CamLine  
 Special Cam Switches

You may also use the direct internet URL:  
<http://194.241.162.3/FICON/FICON075.nsf>

# ON-OFF Switches ①

Cam switches

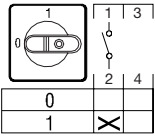

O\_A1\_

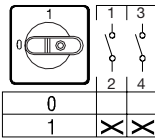

O\_A2\_

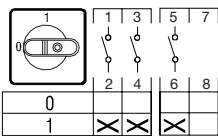

O\_A3\_

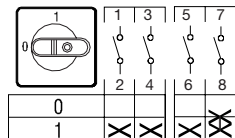

O\_A4\_

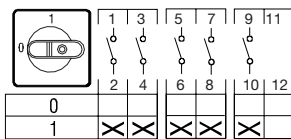

O\_A5\_

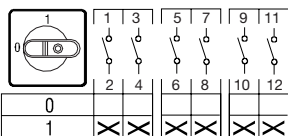

O\_A6\_

Black handle and frontplate with standard text are included. The type and the ordering number are for one piece. Special engraved front-plates to be ordered as separate items.

Function	Number of poles	Rated thermal current [A]	Weight [kg]	Catalog number	List price
----------	-----------------	---------------------------	-------------	----------------	------------

### Rotating angle 90°, O-position: 9 o'clock

Miniature, door mounted

0 - 1	1	10	0.04	OMA1PB	\$ 51
	2	10	0.04	OMA2PB	59
	3	10	0.05	OMA3PB	90
0 - 1	4	10	0.05	OMA4PB	124
	5	10	0.06	OMA5PB	135
	6	10	0.06	OMA6PB	210

Normal, door mounted

0 - 1	1	25	0.08	ONA1PB	53
	2	25	0.09	ONA2PB	66
	3	25	0.10	ONA3PB	102
0 - 1	4	25	0.11	ONA4PB	135
	5	25	0.12	ONA5PB	142
	6	25	0.12	ONA6PB	237

Large, door mounted

0 - 1	1	40	0.13	OL40A1PB	100
	2	40	0.17	OL40A2PB	119
	3	40	0.21	OL40A3PB	136
0 - 1	4	40	0.25	OL40A4PB	150
	5	40	0.29	OL40A5PB	172
	6	40	0.33	OL40A6PB	191

Modular, DIN-rail mounted

0 - 1	1	25	0.09	ONA1M	50
	2	25	0.10	ONA2M	66
	3	25	0.11	ONA3M	102
	6	25	0.12	ONA6M	237

### Key operated, withdrawable in both positions, rotating angle 90°, O-position: 9 o'clock ②

Miniature, door mounted

0 - 1	1	10	0.06	OMA1KB	66
	3	10	0.07	OMA3KB	123

Normal, door mounted 90°

0 - 1	1	25	0.11	ONA1KB	78
	3	25	0.13	ONA3KB	130

Packing sizes: OM 130 x 100 x 120 [mm]  
ON, OL 250 x 100 x 110 [mm]

① 80, 125, 160 & 200A sizes will be available 1st Qtr, 2006. Consult factory for availability.

② Different withdrawability of key is also possible to be ordered as special switch.

Standard delivery with black handle. Available also as an optional extra with grey handle, please change in type designation B to G, eg. OMA1PB would be OMA1PG with grey handle.

# ON - OFF switches ① Change-over switches ①

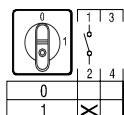

O\_A01\_

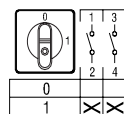

O\_A02\_

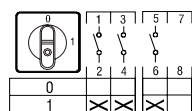

O\_A03\_

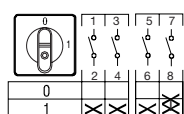

O\_A04\_

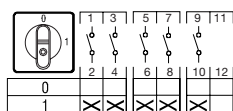

O\_A05\_

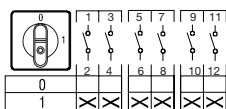

O\_A06\_

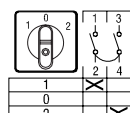

O\_U1\_

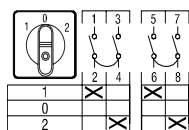

O\_U2\_

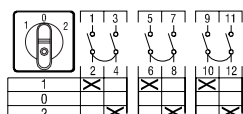

O\_U3\_

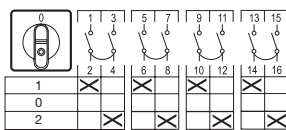

O\_U4\_

## ON - OFF switches

Black handle and frontplate with standard text are included. The type and the ordering number are for one piece, package quantity is 10 pcs. Special engraved frontplates to be ordered as separate items.

Function	Number of poles	Rated thermal current [A]	Weight [kg]	Catalog number	List price
----------	-----------------	---------------------------	-------------	----------------	------------

### Rotating angle 90°, O-position: 12 o'clock

Miniature, door mounted

0 - 1	1	10	0.04	OMA01PB	\$ 51
	2	10	0.04	OMA02PB	59
	3	10	0.05	OMA03PB	90
0 - 1	4	10	0.05	OMA04PB	124
	5	10	0.06	OMA05PB	135
	6	10	0.06	OMA06PB	215

Normal, door mounted

0 - 1	1	25	0.08	ONA01PB	53
	2	25	0.09	ONA02PB	66
	3	25	0.10	ONA03PB	102
0 - 1	4	25	0.11	ONA04PB	135
	5	25	0.12	ONA05PB	142
	6	25	0.12	ONA06PB	237

Modular, DIN-rail mounted

0 - 1	1	25	0.09	ONA01M	50
	2	25	0.10	ONA02M	66
	3	25	0.11	ONA03M	102
	6	25	0.12	ONA06M	237

### Key operated, withdrawable in both positions, rotating angle 90°, O-position: 12 o'clock

Miniature, door mounted

0 - 1	1	10	0.06	OMA01KB	116
	3	10	0.07	OMA03KB	123

Normal, door mounted

0 - 1	1	25	0.11	ONA01KB	140
	3	25	0.13	ONA03KB	130

## Change-over switches

Black handle and frontplate with standard text are included. The type and the ordering number are for one piece, package quantity is 10 pcs. Special engraved frontplates to be ordered as separate items.

### Rotating angle 60° - 0 - 60°

Miniature, door mounted

1 - 0 - 2	1	10	0.05	OMU1PB	56
	2	10	0.06	OMU2PB	85
	3	10	0.06	OMU3PB	124
	4	10	0.07	OMU4PB	143

Normal, door mounted

1 - 0 - 2	1	25	0.09	ONU1PB	65
	2	25	0.11	ONU2PB	88
	3	25	0.13	ONU3PB	135
	4	25	0.14	ONU4PB	150

Large, door mounted

1 - 0 - 2	1	40	0.17	OL40U1PB	114
	2	40	0.25	OL40U2PB	139
	3	40	0.33	OL40U3PB	189
	4	40	0.41	OL40U4PB	244

Modular, DIN-rail mounted

1 - 0 - 2	1	25	0.09	ONU1M	65
	2	25	0.11	ONU2M	88
	3	25	0.13	ONU3M	135
	4	25	0.14	ONU4M	150

Packing sizes: OM 130 x 100 x 120 [mm]  
ON, OL 250 x 100 x 110 [mm]

① 80, 125, 160 & 200A sizes will be available 1st Qtr, 2006. Consult factory for availability.

Standard delivery with black handle. Available also as an optional extra with grey handle, please change in type designation B to G, eg. OMA1PB would be OMA1PG with grey handle.

# Change-over switches ①

Cam switches

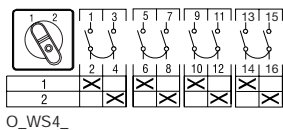
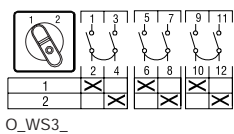
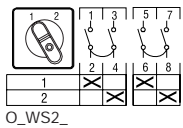
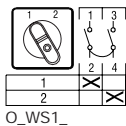
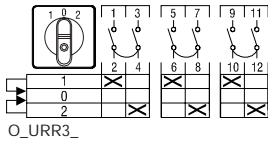
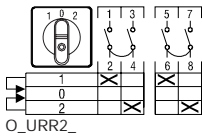
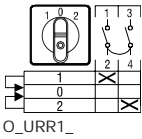
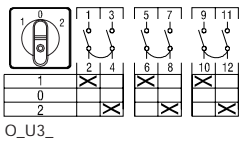
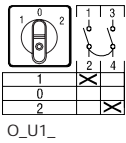

Black handle and frontplate with standard text are included. The type and the ordering number are for one piece. Special engraved frontplates to be ordered as separate items.

Function	Number of poles	Rated thermal current [A]	Weight [kg]	Catalog number	List price
<b>Key operated, with 0-position, withdrawable in all positions</b>					
<b>Miniature, door mounted</b>					
1 - 0 - 2	1	10	0.07	OMU1KB	\$ 107
	3	10	0.08	OMU3KB	159
<b>Normal, door mounted</b>					
1 - 0 - 2	1	25	0.12	ONU1KB	131
	3	25	0.13	ONU3KB	179
<b>1<sub>R</sub> - 0 - 2<sub>R</sub>, with two sided spring return</b>					
<b>Miniature, door mounted</b>					
1 <sub>R</sub> - 0 - 2 <sub>R</sub>	1	10	0.05	OMURR1PB	63
	3	10	0.06	OMURR3PB	130
<b>Normal, door mounted</b>					
1 <sub>R</sub> - 0 - 2 <sub>R</sub>	1	25	0.09	ONURR1PB	79
	2	25	0.11	ONURR2PB	153
	3	25	0.12	ONURR3PB	142
<b>Large, door mounted</b>					
1 <sub>R</sub> - 0 - 2 <sub>R</sub>	1	45	0.17	OL40URR1PB	133
	2	45	0.25	OL40URR2PB	144
	3	45	0.33	OL40URR3PB	189
<b>Modular, DIN-rail mounted</b>					
1 <sub>R</sub> - 0 - 2 <sub>R</sub>	1	25	0.09	ONURR1M	89
<b>Without 0-position</b>					
<b>Miniature, door mounted</b>					
1 - 2	1	10	0.09	OMWS1PB	58
	2	10	0.11	OMWS2PB	79
	3	10	0.13	OMWS3PB	103
	4	10	0.14	OMWS4PB	119
<b>Normal, door mounted</b>					
1 - 2	1	25	0.09	ONWS1PB	66
	2	25	0.11	ONWS2PB	90
	3	25	0.13	ONWS3PB	124
	4	25	0.14	ONWS4PB	144
<b>Large, door mounted</b>					
1 - 2	1	40	0.17	OL40WS1PB	122
	2	40	0.25	OL40WS2PB	150
	3	40	0.33	OL40WS3PB	200
	4	40	0.41	OL40WS4PB	244
<b>Modular, DIN-rail mounted</b>					
1 - 2	1	25	0.09	ONWS1M	66
	2	25	0.11	ONWS2M	90
	3	25	0.13	ONWS3M	124
	4	25	0.14	ONWS4M	166

Packing sizes: OM 130 x 100 x 120 [mm]  
ON, OL 250 x 100 x 110 [mm]

① 80, 125, 160 & 200A sizes will be available 1st Qtr. 2006. Consult factory for availability.

Standard delivery with black handle. Available also as an optional extra with grey handle, please change in type designation B to G, eg. OMA1PB would be OMA1PG with grey handle.

# Multi-step switches ①

Black handle and frontplate with standard text are included. The type and the ordering number are for one piece. Special engraved frontplates to be ordered as separate items.



O\_SO21\_

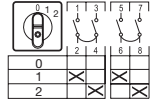

O\_SO22\_

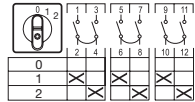

O\_SO23\_

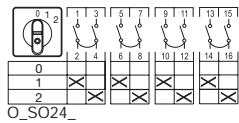

O\_SO24\_

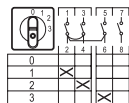

O\_SO31\_

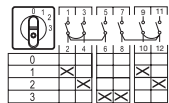

O\_SO32\_

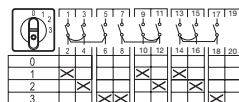

O\_SO33\_

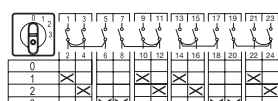

O\_SO34\_

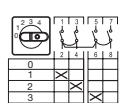

O\_SO41\_

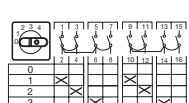

O\_SO42\_

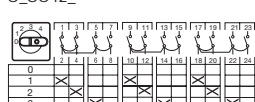

O\_SO43\_

Function	Number of poles	Rated thermal current [A]	Weight [kg]	Catalog number	List price
----------	-----------------	---------------------------	-------------	----------------	------------

### 2- step, with O-position

Miniature, door mounted

0 - 1 - 2	1	10	0.04	OMSO21PB	\$ 58
	2	10	0.05	OMSO22PB	79
	3	10	0.06	OMSO23PB	98
	4	10	0.07	OMSO24PB	113

Normal, door mounted

0 - 1 - 2	1	25	0.10	ONSO21PB	68
	2	25	0.12	ONSO22PB	82
	3	25	0.13	ONSO23PB	111
	4	25	0.14	ONSO24PB	135

Modular, DIN-Rail mounted

0 - 1 - 2	1	25	0.10	ONSO21M	68
-----------	---	----	------	---------	----

### 3- step, with O-position

Miniature, door mounted

0 - 1 - 2 - 3	1	10	0.05	OMSO31PB	68
	2	10	0.06	OMSO32PB	96
	3	10	0.07	OMSO33PB	107
	4	10	0.08	OMSO34PB	160

Normal, door mounted

0 - 1 - 2 - 3	1	25	0.10	ONSO31PB	83
	2	25	0.12	ONSO32PB	101
	3	25	0.13	ONSO33PB	113
	4	25	0.14	ONSO34PB	159

Large, door mounted

0 - 1 - 2 - 3	1	45	0.41	OL40SO31PB	133
---------------	---	----	------	------------	-----

Modular, DIN-rail mounted

0 - 1 - 2 - 3	1	25	0.11	ONSO31M	83
---------------	---	----	------	---------	----

### 3- step, without O-position

Miniature, door mounted

1 - 2 - 3	1	10	0.05	OMST31PB	74
	2	10	0.06	OMST32PB	98
	3	10	0.07	OMST33PB	133
	4	10	0.08	OMST34PB	170

Normal, door mounted

1 - 2 - 3	1	25	0.10	ONST31PB	78
	2	25	0.12	ONST32PB	111
	3	25	0.13	ONST33PB	154
	4	25	0.14	ONST34PB	192

Modular, DIN-rail mounted

1 - 2 - 3	1	25	0.10	ONST31M	78
-----------	---	----	------	---------	----

### 4- step, with O-position

Miniature, door mounted

0 - 1 - 2 - 3 - 4	1	10	0.05	OMSO41PB	79
	2	10	0.06	OMSO42PB	98
	3	10	0.07	OMSO43PB	126

Normal, door mounted

0 - 1 - 2 - 3 - 4	1	25	0.11	ONSO41PB	85
	2	25	0.12	ONSO42PB	119
	3	25	0.13	ONSO43PB	132

### 4- step, without O-position

Miniature, door mounted

1 - 2 - 3 - 4	1	10	0.05	OMST41PB	85
	2	10	0.06	OMST42PB	124
	3	10	0.07	OMST43PB	198

Normal, door mounted

1 - 2 - 3 - 4	1	25	0.11	ONST41PB	90
	2	25	0.12	ONST42PB	136
	3	25	0.13	ONST43PB	215

Packing sizes: OM 130 x 100 x 120 [mm]  
ON, OL 250 x 100 x 110 [mm]

① 80, 125, 160 & 200A sizes will be available 1st Qtr, 2006. Consult factory for availability.

Standard delivery with black handle. Available also as an optional extra with grey handle, please change in type designation B to G, eg.

OMA1PB would be OMA1PG with grey handle.

# Multi-step switches ①

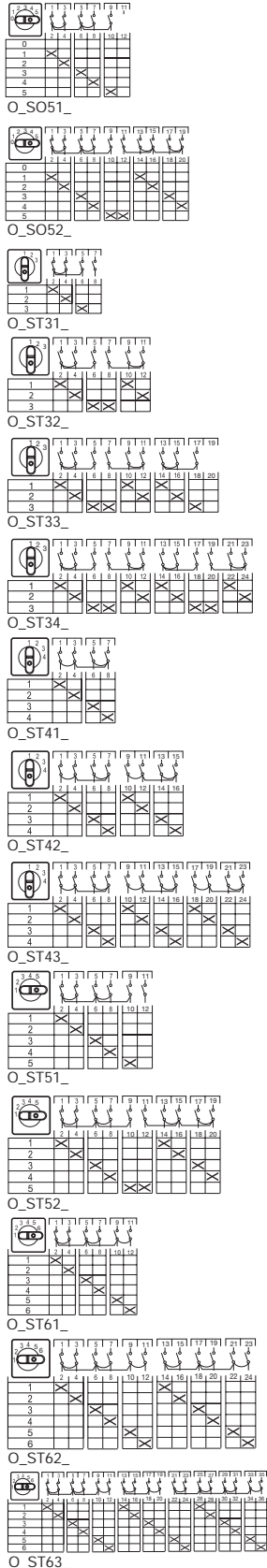

Black handle and frontplate with standard text are included. The type and the ordering number are for one piece, package quantity is 10 pcs. Special engraved frontplates to be ordered as separate items.

Function	Number of poles	Rated thermal current [A]	Weight [kg]	Catalog number	List price
<b>5- step, with O-position</b> Miniature, door mounted					
0 - 1 - 2 - 3 - 4 - 5	1	10	0.06	OMSO51PB	\$ 102
	2	10	0.08	OMSO52PB	147
Normal, door mounted					
0 - 1 - 2 - 3 - 4 - 5	1	25	0.12	ONSO51PB	119
	2	25	0.14	ONSO52PB	166
<b>5- step, without O-position</b> Miniature, door mounted					
1 - 2 - 3 - 4 - 5	1	10	0.06	OMST51PB	117
	2	10	0.08	OMST52PB	155
Normal, door mounted					
1 - 2 - 3 - 4 - 5	1	25	0.12	ONST51PB	135
	2	25	0.14	ONST52PB	165
<b>6-step with 0-position</b> Normal, door mounted					
1-2-3-4-5-6	1	25	0.115	ONSO61PB	145
	2	25	0.19	ONSO62PB	234
	3	25	0.265	ONSO63PB	323
Large, door mounted					
1-2-3-4-5-6	1	40	0.185	OL40SO61PB	267
	2	40	0.305	OL40SO62PB	424
	3	40	0.425	OL40SO63PB	658
<b>6-step without 0-position</b> Normal, door mounted					
1-2-3-4-5-6	1	25	0.115	ONST61PB	167
	2	25	0.19	ONST62PB	267
	3	25	0.265	ONST63PB	357
Large, door mounted					
1-2-3-4-5-6	1	40	0.185	OL40ST61PB	267
	2	40	0.305	OL40ST62PB	412
	3	40	0.425	OL40ST63PB	613

Packing sizes: OM 130 x 100 x 120 [mm]  
ON, OL 250 x 100 x 110 [mm]

① 80, 125, 160 & 200A sizes will be available 1st Qtr, 2006. Consult factory for availability.

Standard delivery with black handle. Available also as an optional extra with grey handle, please change in type designation B to G, eg. OMA1PB would be OMA1PG with grey handle.

## Multi-step switches ①

Black handle and frontplate with standard text are included. The type and the ordering number are for one piece, package quantity is 10 pcs. Special engraved frontplates to be ordered as separate items.

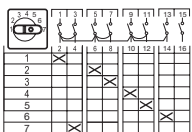

O\_ST71\_

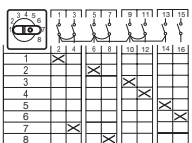

O\_ST81\_

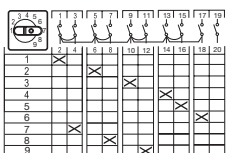

O\_ST91\_

Function	Number of poles	Rated thermal current [A]	Weight [kg]	Catalog number	List price
<b>7-step with 0-position</b>					
Normal, door mounted					
1-2-3-4-5-6-7	1	25	0.14	ONSO71PB	\$ 199
Large, door mounted					
1-2-3-4-5-6-7	1	40	0.3	OL40SO71PB	289
<b>7-step without 0-position</b>					
Normal, door mounted					
1-2-3-4-5-6-7	1	25	0.14	ONST71PB	167
Large, door mounted					
1-2-3-4-5-6-7	1	40	0.3	OL40ST71PB	290
<b>8-step with 0-position</b>					
Normal, door mounted					
1-2-3-4-5-6-7-8	1	25	0.145	ONSO81PB	233
Large, door mounted					
1-2-3-4-5-6-7-8	1	40	0.148	OL40SO81PB	311
<b>8-step without 0-position</b>					
Normal, door mounted					
1-2-3-4-5-6-7-8	1	25	0.145	ONST81PB	233
Large, door mounted					
1-2-3-4-5-6-7-8	1	40	0.148	OL40ST81PB	311
<b>9-step with 0-position</b>					
Normal, door mounted					
1-2-3-4-5-6-7-8-9	1	25	0.165	ONSO91PB	278
Large, door mounted					
1-2-3-4-5-6-7-8-9	1	40	0.265	OL40SO91PB	334
<b>9-step without 0-position</b>					
Normal, door mounted					
1-2-3-4-5-6-7-8-9	1	25	0.165	ONST91PB	200
Large, door mounted					
1-2-3-4-5-6-7-8-9	1	40	0.265	OL40ST91PB	345

① 80, 125, 160 & 200A sizes will be available 1st Qtr, 2006. Consult factory for availability.

Standard delivery with black handle. Available also as an optional extra with grey handle, please change in type designation B to G, eg. OMA1PB would be OMA1PG with grey handle.

# Multi-step switches ①

Cam switches

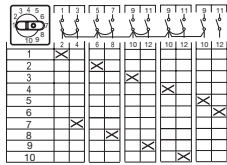

O\_ST101\_

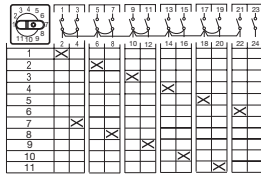

O\_ST111\_

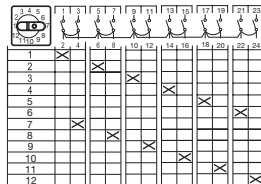

O\_ST121\_

Black handle and frontplate with standard text are included. The type and the ordering number are for one piece, package quantity is 10 pcs. Special engraved frontplates to be ordered as separate items.

Function	Number of poles	Rated thermal current [A]	Weight [kg]	Catalog number	List price
----------	-----------------	---------------------------	-------------	----------------	------------

## 10-step with 0-position

Normal, door mounted

1-2-3-4-5-6-7-8-9-10	1	25	0.17	ONSO101PB	\$ 212
----------------------	---	----	------	-----------	--------

Large, door mounted

1-2-3-4-5-6-7-8-9-10	1	40	0.27	OL40SO101PB	357
----------------------	---	----	------	-------------	-----

## 10-step without 0-position

Normal, door mounted

1-2-3-4-5-6-7-8-9-10	1	25	0.17	ONST101PB	223
----------------------	---	----	------	-----------	-----

Large, door mounted

1-2-3-4-5-6-7-8-9-10	1	40	0.27	OL40ST101PB	357
----------------------	---	----	------	-------------	-----

## 11-step with 0-position

Normal, door mounted

1-2-3-4-5-6-7-8-9-10-11	1	25	0.19	ONSO111PB	245
-------------------------	---	----	------	-----------	-----

Large, door mounted

1-2-3-4-5-6-7-8-9-10-11	1	40	0.305	OL40SO111PB	390
-------------------------	---	----	-------	-------------	-----

## 11-step without 0-position

Normal, door mounted

1-2-3-4-5-6-7-8-9-10-11	1	25	0.19	ONST111PB	245
-------------------------	---	----	------	-----------	-----

Large, door mounted

1-2-3-4-5-6-7-8-9-10-11	1	40	0.305	OL40ST111PB	401
-------------------------	---	----	-------	-------------	-----

## 12-step without 0-position

Normal, door mounted

1-2-3-4-5-6-7-8-9-10-11-12	1	25	0.195	ONST121PB	267
----------------------------	---	----	-------	-----------	-----

Large, door mounted

1-2-3-4-5-6-7-8-9-10-11-12	1	40	0.31	OL40ST121PB	379
----------------------------	---	----	------	-------------	-----

Packing sizes: OM 130 x 100 x 120 [mm]  
ON, OL 250 x 100 x 110 [mm]

11

① 80, 125, 160 & 200A sizes will be available 1st Qtr, 2006. Consult factory for availability.

Standard delivery with black handle. Available also as an optional extra with grey handle, please change in type designation B to G, eg. OMA1PB would be OMA1PG with grey handle.



O\_SE158\_

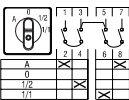

O\_ST301\_

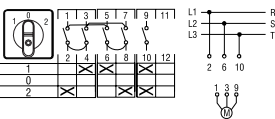

O\_W3\_

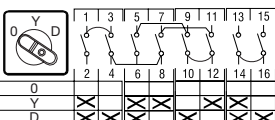

O\_SD\_

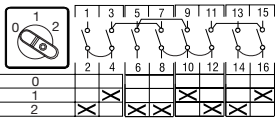

O\_P12\_

## Pumpstart switches

Miniature, door mounted

Function	Number of poles	Rated thermal current [A]	Weight [kg]	Catalog number	List price
0 - 1	1	10	0.04	OMSE158PB	\$ 78

Normal, door mounted

0 - 1	1	25	0.09	ONSE158PB	79
-------	---	----	------	-----------	----

Modular, DIN-rail mounted

0 - 1	1	25	0.09	ONSE158M	100
-------	---	----	------	----------	-----

## Ventilation switches

Black handle and frontplate with standard text are included. The type and the ordering number are for one piece, package quantity is 10 pcs. Special engraved frontplates to be ordered as separate items.

Function	Number of poles	Rated thermal current [A]	Motor rating [kW/400V]	Weight [kg]	Catalog number	List price
----------	-----------------	---------------------------	------------------------	-------------	----------------	------------

Miniature, door mounted

A - 0 - 1/2 - 1/1	2	10	7.5	0.06	OMST301PB	\$ 74
-------------------	---	----	-----	------	-----------	-------

Normal, door mounted

A - 0 - 1/2 - 1/1	2	25	7.5	0.11	ONST301PB	78
-------------------	---	----	-----	------	-----------	----

Modular, DIN-rail mounted

A - 0 - 1/2 - 1/1	2	25	7.5	0.11	ONST301M	78
-------------------	---	----	-----	------	----------	----

Large, door mounted

A - 0 - 1/2 - 1/1	2	40	15	0.21	OL40ST301PB	139
-------------------	---	----	----	------	-------------	-----

## Reversing switches

Black handle and frontplate with standard text are included. The type and the ordering number are for one piece, package quantity is 10 pcs.. Special engraved frontplates to be ordered as separate items.

Normal, door mounted

1 - 0 - 2	3	25	7.5	0.10	ONW3PB	130
-----------	---	----	-----	------	--------	-----

Large, door mounted

1 - 0 - 2	3	40	15	0.21	OL40W3PB	233
-----------	---	----	----	------	----------	-----

## Star-delta switches

Normal, door mounted

0 - Y - ΔΔ	3	25	7.5	0.12	ONSDEPB	222
------------	---	----	-----	------	---------	-----

Large, door mounted

0 - Y - Δ	3	40	15	0.21	OL40SDEPB	368
-----------	---	----	----	------	-----------	-----

## Pole-change switches (Dahlander)

Winding for 2 speeds, one direction, 0 - A - AYY

Normal, door mounted

0 - 1 - 2	3	25	7.5	0.12	ONP12PB	234
-----------	---	----	-----	------	---------	-----

Large, door mounted

0 - 1 - 2	3	40	15	0.25	OL40P12PB	312
-----------	---	----	----	------	-----------	-----

Packing sizes: OM 130 x 100 x 120 [mm]  
ON, OL 250 x 100 x 110 [mm]

Standard delivery with black handle. Available also as an optional extra with grey handle, please change in type designation B to G, eg. OMA1PB would be OMA1PG with grey handle.

# Voltmeter switches



Black handle and frontplate with standard text are included. The type and the ordering number are for one piece, package quantity is 10 pcs. Special engraved frontplates to be ordered as separate items.

Function	Number of stages	Rated thermal current [A]	Weight kg	Catalog number	List price
----------	------------------	---------------------------	-----------	----------------	------------

### 4 Positions, 3 phase -3 wire, with 0-position

Miniature, door mounted

0, L1-L2,L2-L3,L3-L1	2	10	0.06	OMV3PB	\$ 79
----------------------	---	----	------	--------	-------

Normal, door mounted

0, L1-L2,L2-L3,L3-L1	2	25	0.11	ONV3PB	86
----------------------	---	----	------	--------	----

Modular, DIN-rail mounted

0, L1-L2,L2-L3,L3-L1	2	25	0.11	ONV3M	86
----------------------	---	----	------	-------	----

### 3 Positions, 3 phase -3 wire, without 0-position

Miniature, door mounted

L1-L2,L2-L3,L3-L1	2	10	0.06	OMVN3PB	79
-------------------	---	----	------	---------	----

Normal, door mounted

L1-L2,L2-L3,L3-L1	2	25	0.11	ONVN3PB	113
-------------------	---	----	------	---------	-----

Modular, DIN-rail mounted

L1-L2,L2-L3,L3-L1	2	25	0.11	ONVN3M	113
-------------------	---	----	------	--------	-----

### 7 Positions, 3 phase to phase 3 phase to neutral, without 0-position

Miniature, door mounted

L1-L3,L2-L3,L1-L2 L1-N,L2-N,L3-N	3	10	0.08	OMVN30PB	128
-------------------------------------	---	----	------	----------	-----

Normal, door mounted

L1-L3,L2-L3,L1-L2 L1-N,L2-N,L3-N	3	25	0.12	ONVN30PB	113
-------------------------------------	---	----	------	----------	-----

Modular, DIN-rail mounted

L1-L3,L2-L3,L1-L2 L1-N,L2-N,L3-N	M	25	0.12	ONVN30M	113
-------------------------------------	---	----	------	---------	-----

### 7 Positions, 3 phase to phase 3 phase to neutral, with 0-position

Miniature, door mounted

L1-L3,L2-L3,L1-L2,0 L1-N,L2-N,L3-N	3	10	0.12	OMV30PB	102
---------------------------------------	---	----	------	---------	-----

Normal, door mounted

L1-L3,L2-L3,L1-L2,0 L1-N,L2-N,L3-N	3	25	0.12	ONV30PB	113
---------------------------------------	---	----	------	---------	-----

Modular, DIN-rail mounted

L1-L3,L2-L3,L1-L2,0 L1-N,L2-N,L3-N	3	25	0.12	ONV30M	113
---------------------------------------	---	----	------	--------	-----

### 7 Positions, 3 phase to phase voltages for 2 circuits, with 0 position

Miniature, door mounted

L1-L3,L2-L3,L1-L2,0 L1-L3,L2-L3,L1-L2	4	10	0.14	OMV32PB	159
--	---	----	------	---------	-----

Normal, door mounted

L1-L3,L2-L3,L1-L2,0 L1-L3,L2-L3,L1-L2	4	25	0.14	ONV32PB	192
--	---	----	------	---------	-----

Packing sizes: OM 130 x 100 x 120 [mm]  
ON 250 x 100 x 110 [mm]

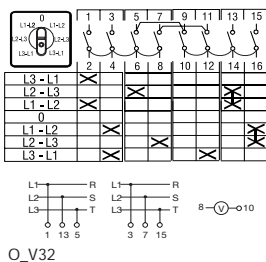
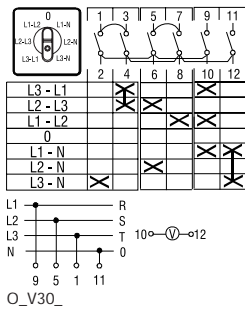
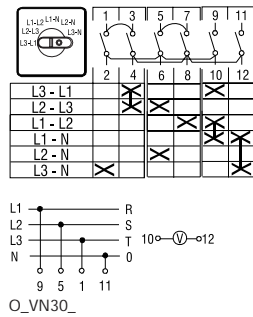
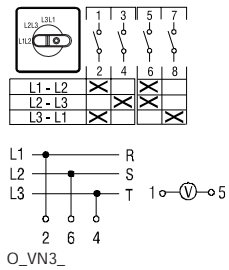
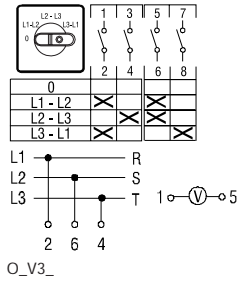

Standard delivery with black handle. Available also as an optional extra with grey handle, please change in type designation B to G, eg. OMA1PB would be OMA1PG with grey handle.

# Ammeter switches

Black handle and frontplate with standard text are included. The type and the ordering number are for one piece, package quantity is 10 pcs. Special engraved frontplates to be ordered as separate items.

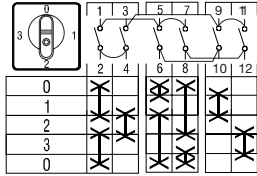

O\_AU31

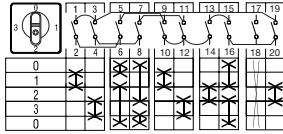

O\_AU32

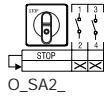

O\_SA2\_

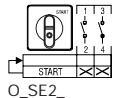

O\_SE2\_

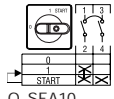

O\_SEA10\_

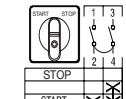

ONSEA1PB

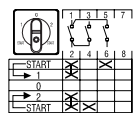

O\_UR139\_

Function	Number of stages	Rated thermal current [A]	Weight kg	Catalog number	List price
----------	------------------	---------------------------	-----------	----------------	------------

### For 3 current transformer circuits, with 0-position

Miniature, door mounted

Single pole	3	10	0.12	OMAU31PB	\$ 102
-------------	---	----	------	----------	--------

Normal, door mounted

Single pole	3	25	0.12	ONAU31PB	113
2 pole or direct measurement in 3 phases	5	25	0.15	ONAU32PB	

Modular, DIN-rail mounted

Single pole	4	25	0.12	ONAU31M	244
-------------	---	----	------	---------	-----

### Stop switches

Black handle and frontplate with standard text are included. The type and the ordering number are for one piece, package quantity is 10 pcs. Special engraved frontplates to be ordered as separate items.

Miniature, door mounted, with spring return, contacts N.C.

O <sub>R</sub> -Stop	2	10	0.04	OMSA2PB	56
----------------------	---	----	------	---------	----

Normal, door mounted, with spring return, contacts N.C.

O <sub>R</sub> -Stop	2	25	0.09	ONSA2PB	66
----------------------	---	----	------	---------	----

### Start switches

Black handle and frontplate with standard text are included. The type and the ordering number are for one piece, package quantity is 10 pcs. Special engraved frontplates to be ordered as separate items. With spring return.

Miniature, door mounted, with spring return.

O <sub>R</sub> -Start	1	10	0.04	OMSE2PB	56
0-1 <sub>R</sub> -Start	1	10	0.05	OMSEA10PB	

Normal, door mounted, with spring return.

Stop-Start	1	25	0.04	ONSEA1PB	83
O <sub>R</sub> -Start	1	25	0.04	ONSE2PB	83
0-1 <sub>R</sub> -Start	1	25	0.09	ONSEA10PB	66
Start-1 <sub>R</sub> -0-2 <sub>R</sub> -Start	1	25	0.09	ONUR139PB	159

Modular, DIN-rail mounted, with spring return

0-1 <sub>R</sub> -Start	1	25	0.09	ONSEA10M	89
Start-1 <sub>R</sub> -0-2 <sub>R</sub> -Start	1	25	0.09	ONUR139M	159

Packing sizes: OM 130 x 100 x 120 [mm]  
ON 250 x 100 x 110 [mm]

Standard delivery with black handle. Available also as an optional extra with grey handle, please change in type designation B to G, eg. OMA1PB would be OMA1PG with grey handle.

# Accessories

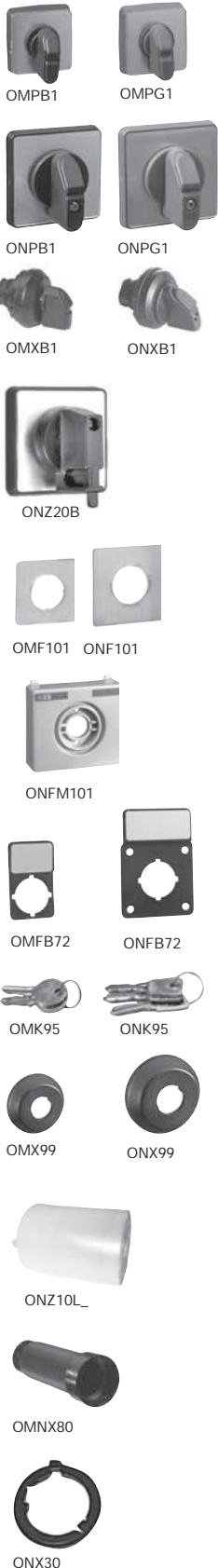

The type and the ordering number are for one piece.

Color	For cam switches type	Packing quantities	Weight kg	Catalog number	List price
-------	-----------------------	--------------------	-----------	----------------	------------

### Handle with blank front plate without engraving

Black	OM_, Mini	5	0.05	OMP B1	\$ 51
Grey	OM_, Mini		0.05	OMPG1	
Black	ON_Normal, OL40	5	0.08	ONPB1	60
Grey	ON_Normal, OL40		0.08	ONPG1	

### Handle with round escutcheon plate

Black	OM_, Mini	5	0.02	OMXB1	66
Black, nose-type	OM_, Mini		0.02	OMXNB1	66
Black	ON_Normal, OL40		0.02	ONXB1	72

### Padlockable handle

For max 2 padlocks with 6 mm ball diameter or for max 3 padlocks with 4 mm ball diameter, 90 degrees.

Black	ON_Normal, OL40	5	0.06	ONZ20B	41
Red yellow	ON_Normal, OL40		0.06	ONZ20RY	28

### Front ring only

Black	OM_, Mini	10	0.01	OMX99	13
Black	ON_, Normal		0.01	ONX99	

### Front plate, blank without engraving ①

Silver	OM_, Mini	10	0.003	OMF101	7
Silver	ON_, Normal		0.003	ONF 101	8
Yellow	ON_ Normal, OL40		0.003	ONFY 101	17
Grey	ON_, Modular		0.003	ONFM 101	17

### Additional lettering plate, without engraving, black engraving from front side ②

Black frame	OM_, Mini	5	0.01	OMFB72	12
Black frame	ON_, Normal, OL40		0.01	ONFB72	12
Grey frame	OM_, Mini		0.01	OMFG72	12
Grey frame	ON_, Normal		0.01	ONFG72	13

### Spare key

2 pcs	OM_, Mini	2	0.01	OMK95	56
3 pcs	ON_, Normal, OL40		0.01	ONK95	68

### Protective rear cover

Transparent, IP 42 protection

Number of chambers	Contacts	For cam switches type	Packing quantities	Weight kg	Catalog number	List price
1-2	2-4	ON_, Normal	1	0.02	ONZ10L2	\$ 39
3-4	6-8	ON_, Normal		0.04	ONZ10L4	52
5-6	10-12	ON_, Normal		0.06	ONZ10L6	69

### Nut spanner for mounting the handle to the door

Black	OM_, Mini ON_, Normal	1	0.02	OMNX80	30
-------	--------------------------	---	------	--------	----

### Adaptor ring for 30 mm door drilling

Black	ON_, Normal	10	0.01	ONX30	10
-------	-------------	----	------	-------	----

① Special front plate for standard switches: order as separate position. Attach specification in electronic format or paper. Eg. ONF 101/TEXT  
 ② Additional lettering plate with engraving: order as separate position. Attach specification in electronic format or paper. The text can also be typed as comment. Eg. ONFB 72/TEXT Pumping station

## Accessories

Available for special cam switches



ONZ74\_



O\_Z31\_



O\_Z21\_

The type and the ordering number are for one piece.  
Special cam switches to be specified by CAMWEB configurator.

### Base mounting switches

Base mounting kit includes base for DIN-rail mounting, shaft adaptor and 200 mm shaft for cutting up to 250 mm panel depth. Can be supplied also as optional extra.

Depth[mm]	For cam switches	Catalog number	List Price
250	ON_Normal	ONZ74	\$ 38

### Cylinder interlock

To lock all pre-determined positions with a safety key (2 pcs)  
Available for special cam switches only. Special configuration with CAMWEB.

	OL_Large	OLZ31	368
--	----------	-------	-----

### Pushbutton interlock

To release all pre-determined positions while pushed. Special configuration with CAMWEB.

	OL_Large	OLZ21	167
--	----------	-------	-----

# Technical data ①

## According to IEC / 60947-3-4-5

Cam switches

IEC ratings				OM_	ON_	OL40
<b>Resistive and inductive load</b>						
<b>AC ratings</b>						
Impulse withstand voltage	$U_{imp}$		kV	-	-	6
Rated operating voltage $U_e$	IEC		V	500	690	690
Isolation conditions acc. to VDE			V	250	400	690
Rated thermal current $I_{th}$	IEC		A	10	25	45
Rated short circuit current (prospective)			kA	1	10	10
Max back up fuse link			A	10	25	40
Short time current carrying capacity		3s	A	-	100	360
		10s	A	-	60	200
		30s	A	-	32	120
		60s	A	-	30	80
Rated operational current $I_e$			A	10	25	45
Non- or slightly inductive load	AC1	380 V	A	10	25	45
Switching of resistive loads	AC21	400 V	A	10	25	45
Switching of magnetic drives relays, valves, traction magnets	AC11	220-240 V	A	2.5	5.5	14
		380-440	A	-	3.5	6
		500 V	A	-	4.5	7
Mixed resistive and inductive load, pf. 0,7	AC22	220-500 V	A	10	20	40
		660-690 V	A	-	20	40
<b>DC ratings</b>						
Switching capacity DC rated voltage with resistive circuits (T ≤ 1ms)	DC1	24 V	A	10	10	45
		40 V	A	6	10	20
		60 V	A	2.5	3	5
		110 V	A	0.7	0.8	1
		220 V	A	0.3	0.32	0.3
		440 V	A	-	0.22	0.25
Switching capacity DC rated voltage with inductive circuits (T < 50 ms)	DC1	24 V	A	6	10	45
		30 V	A	3	4.5	11
		40 V	A	1	1.7	4
		60 V	A	0.7	0.7	1.5
		110 V	A	0.3	0.3	0.4
<b>Motor ratings</b>						
<b>AC ratings</b>						
Rated operational power	AC2	220-240 V	kW	2.5	3.5	11
3-phase		380-440 V	kW	-	6	18.5
Starting of slip-ring, switching off		500 V	kW	-	6	18.5
		660-690 V	kW	-	6	18.5
Rated operational power	AC3	220-240 V	kW	1.8	2.2	7.5
3-phase, 3-pole		380-440 V	kW	2.2	5.5	11
Direct starting of squirrel cage motors, switching off running motors		500 V	kW	-	4	11
		660-690 V	kW	-	4	11
1-phase		110 V	kW	0.3	0.4	2.5
		220-240 V	kW	0.55	0.75	4
		400 V	kW	0.75	1.3	5.5
Rated operational power	AC23	220-240 V	kW	1.8	2.6	7.5
3-phase, 3-pole		<b>380-440 V</b>	<b>kW</b>	<b>3.0</b>	<b>7.5</b>	<b>15</b>
Occasional switching of motors or other highly-inductive devices load		500 V	kW	-	4.8	15
		660-690 V	kW	-	4.8	17
1-phase		110 V	kW	0.37	0.5	2.5
		220-240 V	kW	0.75	0.9	4
		380-440 V	kW	1.1	1.5	7.5

① 80, 125, 160 & 200A sizes will be available 1st Qtr, 2006. Consult factory for availability.

### UL and CSA ratings

UL 508 Manual Motor Controller file number E 63822

			OM_	ON_	OL_40	OL80	OL125	OL160	OL200
Maximum operating voltage	VAC		300	600	600	600	600	600	600
Ampere rating	Pilot duty	CSA/UL category	A300	A600	A600	A600	A600	A600	A600
	General use	CSA/UL	10	25	40	80	125	160	200
Rated power (HP)	120V	HP	1	1	5	10	15	15	32
3-phase	240V	HP	1	1	10	30	40	40	64
	480V	HP	-	2	20	40	50	50	120
	600V	HP	-	5	23	40	50	50	120
1-phase	120V	HP	0.33	.05	2	7.5	10	10	—
	240V	HP	0.75	1	3	15	20	20	—
	480V	HP	-	2	10	—	—	—	—
	600V	HP	-	3	10	—	—	—	—
<b>Short circuit ratings</b>									
Maximum prospective fault current	kA		1	10	10	10	10	10	10
Maximum fuse size	A		16	35(RK5)	50(RK3)	100(RK5)	150(RK5)	200(RK5)	—
Switching frequency	cycles/h		150	150	150	150	150	150	—
Connecting screws	M		2.5	3.5	5	5	5	5	10
Max. cable cross section	mm <sup>2</sup>		1.5	4	6	70	70	70	150
	AGW		14	14-12	14-8(Cu75)	12-2/0	12-2/0	12-2/0	300 kcmil

### Approvals:

UL-Approval, file number EG 63822  
 CSA-Approval  
 Lloyds Register of Shipping  
 Det Norske Veritas (DNV)  
 Germanischer Lloyd (GL)  
 Ghost R



ON\_, Normal



ON\_M, Modular



OM\_, Miniature

### Standards:

IEC 60947-3  
 EN 60947-3  
 UL 508  
 CSA C22.2 No14



OL\_, Large

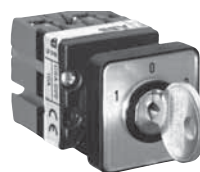

OM\_, Key operated

# Approximate dimensions OM, ON and OL switches

Dimensions in mm.  
Remark: Terminal screws on top and bottom side.

## OM, Miniature

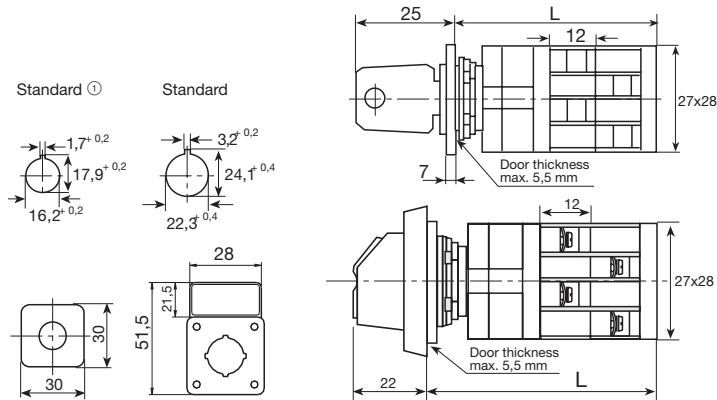

L number of contact chambers

	1	2	3	4	5	6	7	8
	45	57	69	81	90	105	111	138

## ON, Normal

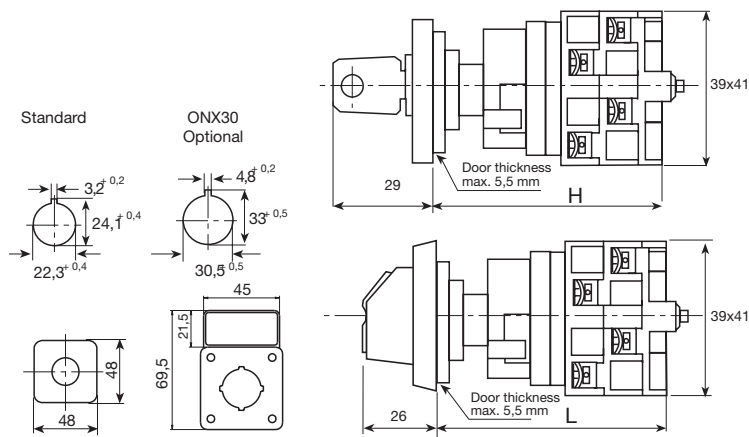

L number of contact chambers

	1	2	3	4	5	6	7	8	9	10
L	54	66	78	90	102	114	126	138	150	162
H	62	76	86	98	110	122	134	146	159	171

① 22mm adaptor ring can be removed and become 16mm.

## Approximate dimensions ON and OL cam switches

Dimensions in mm.

### ON, Modular

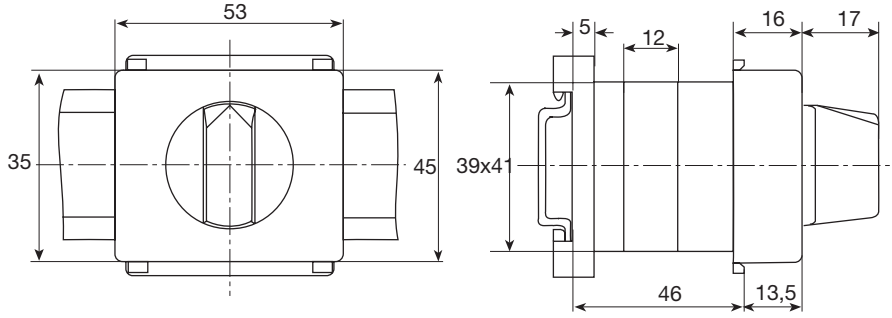

### 11 OL, Large

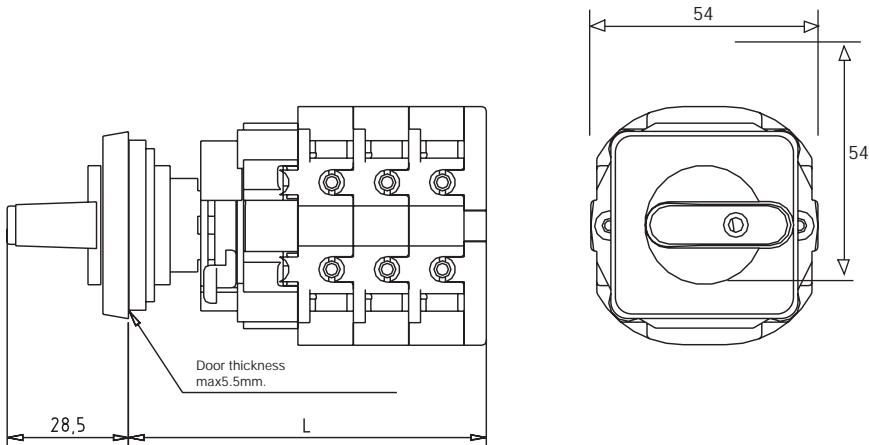

#### Standard

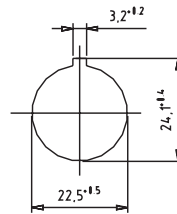

#### ONX30 (Optional)

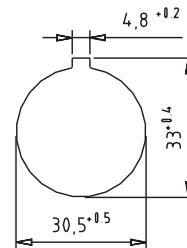

L number of contact chambers

1	2	3	4	5	6	7	8	9	10
59	72	85	98	111	124	137	150	163	176

# Approximate dimensions OL Cam switches



## OL 80, OL125, & OL150

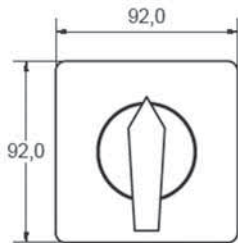
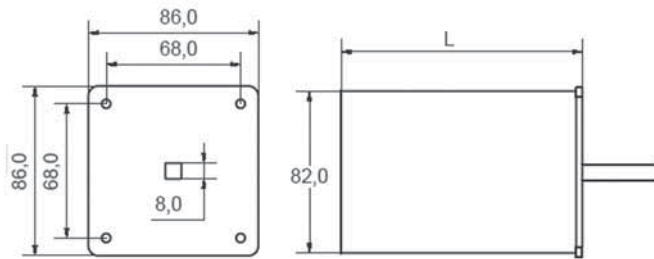

No. of Contacts	Length L
1 - 2	66
3 - 4	94
5 - 6	122
7 - 8	150
9 - 10	178
11 - 12	206
13 - 14	234
15 - 16	262

## OL 200

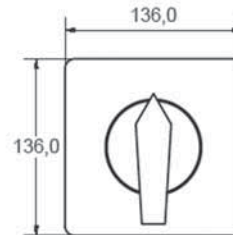
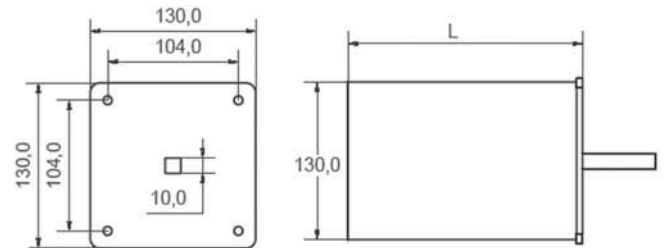

No. of Contacts	Length L
1 - 2	120
3 - 4	181
5 - 6	242
7 - 8	303
9 - 10	364
11 - 12	425
13 - 14	486
15 - 16	547



Special cam switches, contact plan

Company \_\_\_\_\_

Type \_\_\_\_\_

Phone/Fax nr. \_\_\_\_\_

Project number \_\_\_\_\_

Name \_\_\_\_\_

Customer's number \_\_\_\_\_

Quantity: \_\_\_\_\_ pcs

Handled by: \_\_\_\_\_

Date: \_\_\_\_\_

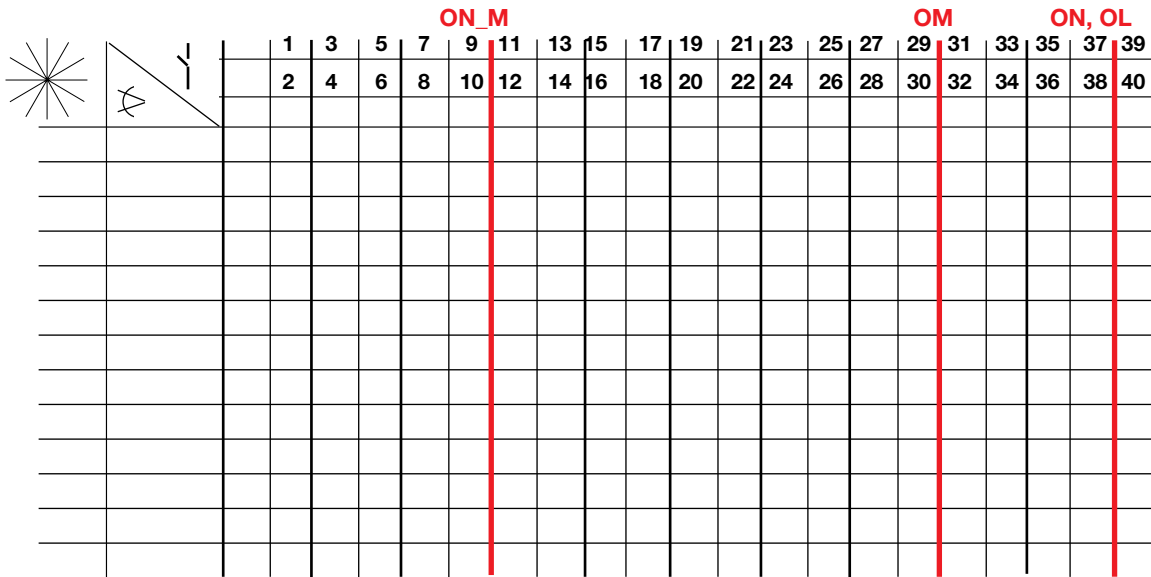
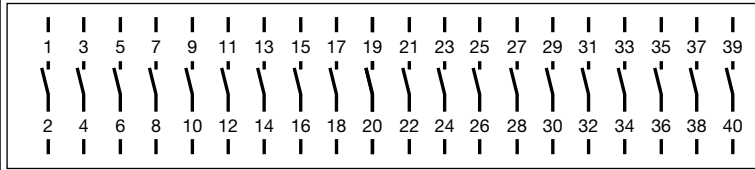
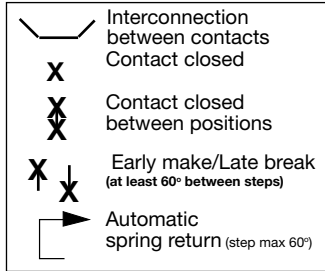

	Normal	Padlockable_X20	Key operated_K	Enclosed_E_6 IP65	Cylinder locking	Pusbutton locking
Black_B						
Grey_G						
Red-yellow_RY						

Door mounting

- OM, 10A
- ON, 25A
- OL, 40A
- OL, 80A
- OL, 125A
- OL, 160A
- OL, 200A

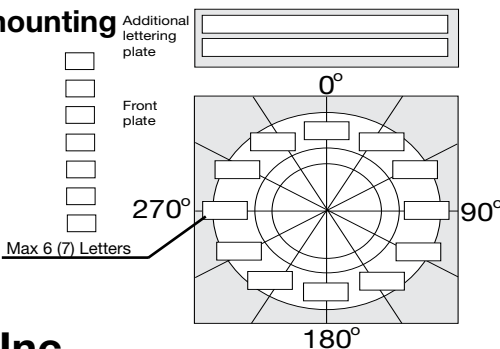

DIN-rail mounting

ON\_M, Modular



ABB Inc.



## Enclosed rotary cam switches

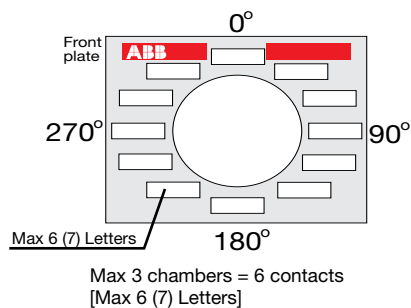

## Enclosed cam switches

The type and the ordering number are for one piece, the package quantity is four pieces.

Neutral and earth terminal, 6mm<sup>2</sup> included

Number of poles	Function	Size of <sup>①</sup> enclosure	Weight [kg]	Catalog number	List price
<b>ON-OFF switches, IP65</b>					
2	0 - 1	96x96x70	0.3	ONA2EPB	\$ 227
3	0 - 1	96x96x70	0.3	ONA3EPB	247
4	0 - 1	96x96x70	0.3	ONA4EPB	245
5	0 - 1	96x96x85	0.3	ONA5EPB	279
6	0 - 1	96x96x85	0.3	ONA6EPB	301
8	0 - 1	96x96x108	0.3	ONA8EPB	379
9	0 - 1	96x96x138	0.3	ONA9EPB	400

<b>ON - OFF switches, padlockable handle, IP65</b>					
2	0 - 1	96x96x70	0.3	ONA2EZB	279
3	0 - 1	96x96x70	0.3	ONA3EZB	312
4	0 - 1	96x96x70	0.3	ONA4EZB	334
5	0 - 1	96x96x85	0.3	ONA5EZB	357
6	0 - 1	96x96x85	0.3	ONA6EZB	379
8	0 - 1	96x96x108	0.3	ONA8EZB	401
9	0 - 1	96x96x138	0.3	ONA9EPB	446

<b>ON - OFF switches, key type, IP54</b>					
3	0 - 1	96x96x100	0.3	ONA3EKB	379

<b>Change-over switches</b>					
1	1 - 0 - 2	96x96x100	0.3	ONU1EPB	222

<b>Reversing switches</b>					
3	1 - 0 - 2	96x96x100	0.3	ONW3EPB	311

<b>Star delta switches</b>					
25	0 - Y - ΔΔ	305x215x185	0.3	ONSDEPB	222
40	0 - Y - ΔΔ	305x215x185	0.4	OL40SDEPB	

### Enclosures

#### Anonymous enclosures

The enclosures can accommodate cam switches for door mounting and OT-switches for door and base mounting, see following pages. Includes fastening rings.

Neutral and earth terminal, 6mm<sup>2</sup> included

Number of contacts	Protection- Class	Size of enclosure	Weight [kg]	Catalog number	List price
<b>ON-OM: 4 contacts, 2 stages, OL: 2 contacts, 1 stage</b>					
	IP 54	96x96x70	0.2	OTC25M25	\$ 45
	IP 65	96x96x70	0.2	OTC26M25	49
<b>ON-OM: 6 contacts, 3 stages, OL: 4 contacts, 2 stages</b>					
	IP54	96x96x84.5	0.2	OTC35M25	53
	IP65	96x96x84.5	0.2	OTC36M25	56
<b>ON-OM: 10 contacts, 5 stages, OL: 6 contacts, 3 stages</b>					
	IP 54	96x96x108	0.2	OTC45M25	65
	IP 65	96x96x108	0.2	OTC46M25	69
<b>ON-OM: 6 contacts, 3 stages, wide, OL: 4 contacts, 2 stages</b>					
	IP 65	161x100x80	0.2	OTC36LM25	67
	NEMA 4x	161x100x80	0.2	OTC36NPT3/4	67

<sup>①</sup> The height without handle.

Special enclosed cam switches configured by CAMWEB tool.



ONA\_EPB



ONA3EKP



ONA\_EZB



OTU16B3M6



OTC2\_M25



OTC3\_M25

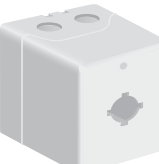

OTC4\_M25



OTC36LM25

## Approximate dimensions Enclosed cam switches

OTC\_

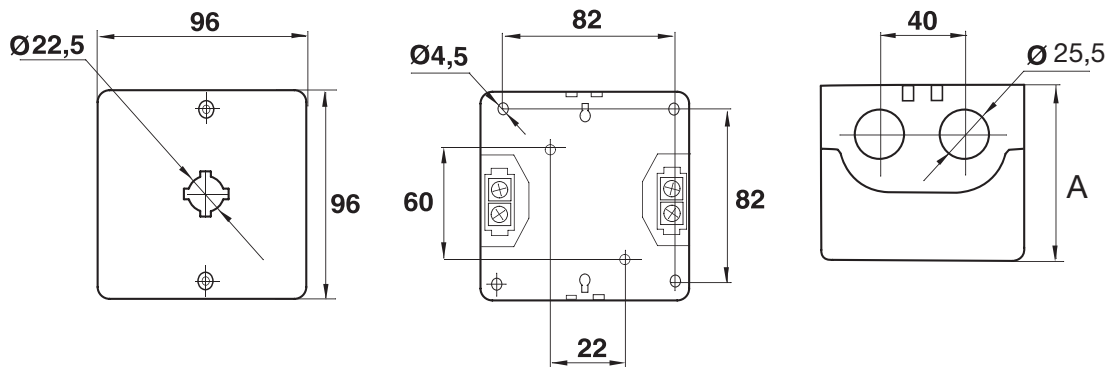

Catalog number	A/mm outside	A/mm inside
OTC2_M25	70	61
OTC3_M25	84.5	75.5
OTC4_M25	108	99

OTC36LM25

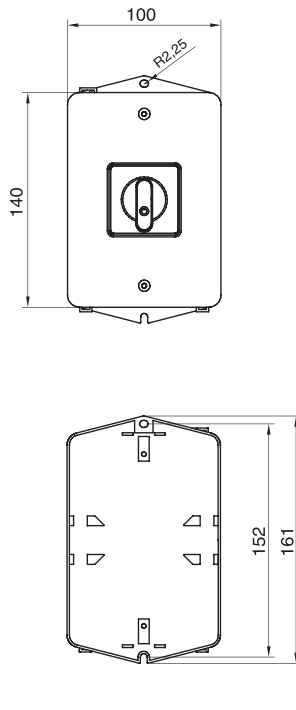



## Notes

---