

Cable management systems

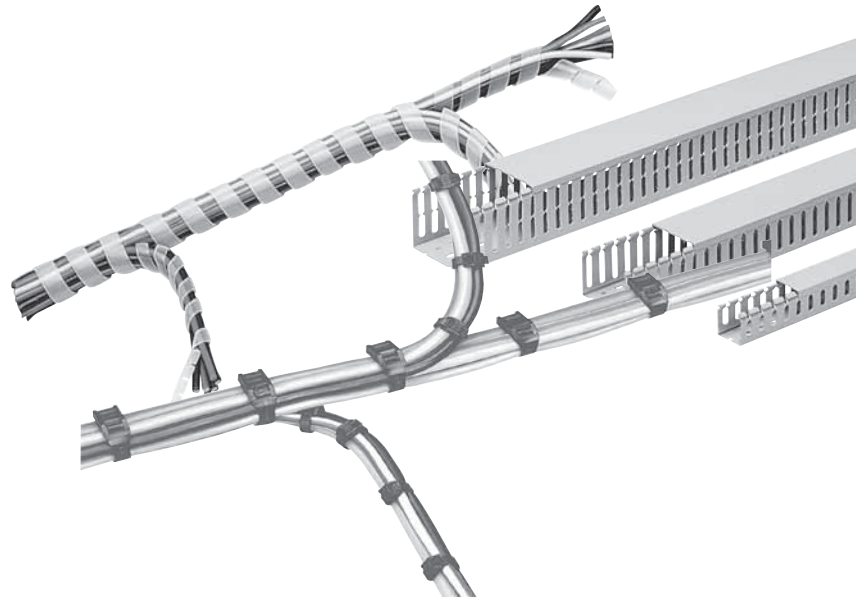

Cable management systems

- Wire duct
- Cable ties
- Spiral wrap



General information

Those requiring considerable space for cables will find their needs met by ABB cable management systems, now also available in the 100 mm height and in a choice of six different base sizes (25, 40, 60, 80, 100 and 150 mm). New wiring ducts join the established designs (with heights between 17 and 80 mm), bringing to 28 the total size combinations offered, all available with 8 – 12 mm and 4 – 6 mm slots.



Less complicated work brings installers and panel builders faster solutions thanks to the new top profile of the ribs.

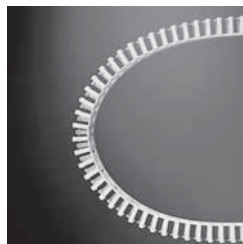

The new flexible thermoplastic wiring ducts solve every electrical switchboard and distribution switchboard wiring problem.

The best solution for hinged panels and doors are our new flexible thermoplastic cable management systems (available in seven sizes), which are ideal for every situation in which wiring is subject to flexion or torsion.

A new design of cable management systems with circular knockouts in the sides to facilitate branch connections using rigid and corrugated conduits has also been introduced for environments in which cables require greater protection against external agents (elevator rooms are a typical example).



New wiring ducts with circular knockouts in the sides are available for any specific kind of branch connections.

The updated range is completed by installation accessories and tools: plastic rivets, wire stops, label tags, new wiring ducts bases, a new rivet gun and shears.

The top profile of the ribs of these wiring ducts has been redesigned to make it easier to open and close the cover and to ensure even more secure engagement.



All in one movement: thanks to the controlled splaying of the sides, gentle pressure is all it takes to fix the cover on the duct, forming a perfect seal in all conditions, even in environments that reach high temperatures.

To release it, simply press the ribs inwards with one hand.

continued next page

General information

Wire duct, cable ties, spiral wrap

The cover can't slide in vertical sections, nor is the bottom rib affected by the weight of the cables in horizontal sections.

The exceptional care with which ABB wiring ducts are manufactured also ensures a clean internal finish. Because there aren't any plastic burrs you can work hour after hour without your hands suffering the consequences.

The dimensions and resilience of the ribs on ABB cable management systems ensure they can be moved apart many times during the wiring phase. But when you need to remove the rib to create openings for letting cables in or out, the special knockouts allow you to make an instant clean break. The base of the wall also features knockouts that make it possible to cut the edge when you want to make level branch connections.

The 80 and 100 mm high versions feature cable holder moldings in the middle of the straight sections of the ribs.

The new ABB cable management systems are in a class of their own when it comes to ease of installation. In fact they have been made for snap-on installation to a new accessory that's been specially designed for fast fitting both to DIN rails and base plates. The new bottom profile of the wiring ducts has been changed and no longer needs drilling or rivets. Thanks to this new accessory, mounting and removal both take no more than a click.

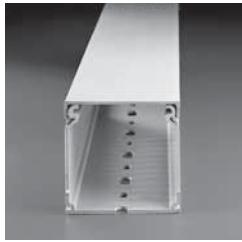

All the space cables need with the new wiring ducts available in the 100 mm height and six different base sizes.

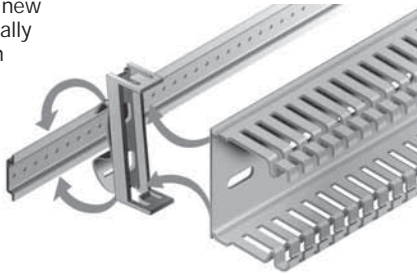

How do you connect the switchgears installed on switchboard doors? Our new flexible cable management systems can be bent or twisted without breaking and allow you to solve all manner of connection problems where hinged moving parts are concerned. They are quick and easy to use: the offset position of the ribs and the way they are angled slightly downwards makes it easier to insert and extract the cables.

These new ducts save time and energy compared to traditional coiled designs. When you need to add new cables, change and inspect them or carry out maintenance, the operations required are simple and take next to no time at all. Simply pull out the cables or feed in new ones without having to unwind or rewind the coils. The flexible wiring ducts are supplied as standard with ready-fitted double-sided adhesive tape offering high adhesion on steel. And you can, of course, naturally fit them using screws and rivets as well. They engage in special slots on the bottom that are orientated in two axes to enable the position of the ducts to be adjusted.

In those cases in which it's advantageous to protect cables from dust (IP 40) while retaining maximum installation flexibility, we designed these new cable management systems with circular knockouts in the sides for branch connections with rigid or corrugated conduits (with or without tube clamps) or directly with cables. The neck of the hole also forms part of the knockout, making it easier to install the cables and branch connections in any work phase and conditions.

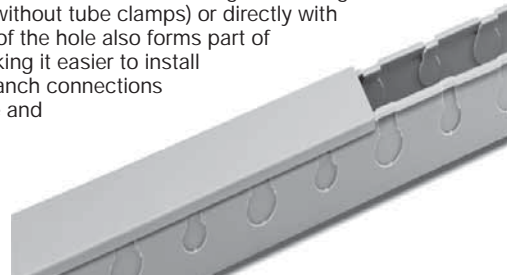

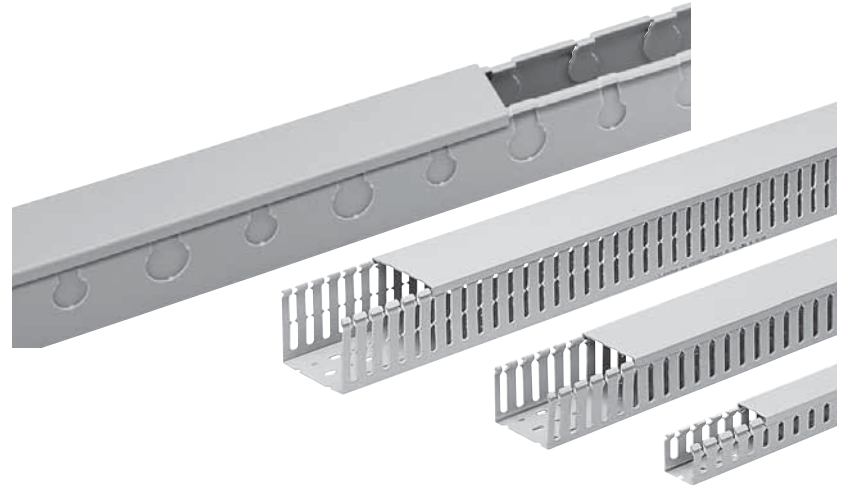

Description

ABB wiring ducts are now also available in the 100 mm height and in a choice of six different base sizes (25, 40, 60, 80, 100 and 150 mm). These new wiring ducts join the established designs (with heights between 17 and 80 mm), bringing to 28 the total size combinations offered, all available with 8 – 12 mm and 4 – 6 mm slots.

Flexible thermoplastic wiring ducts (available in seven sizes) are ideal for every situation in which wiring is subject to flexion or torsion.

A new design of wiring ducts with circular knockouts in the sides to facilitate branch

connections using rigid and corrugated conduits has also been introduced for environments in which cables require greater protection against external agents (elevator rooms are a typical example).

The updated range is completed by installation accessories and tools: plastic rivets, wire stops, label tags, new wiring ducts bases, a new rivet gun and shears.

The 80 and 100 mm high versions feature cable holder moldings in the middle of the straight sections of the ribs.

Wiring duct, gray

Standard; 8 – 12 mm slot
High density; 4 – 6 mm slot

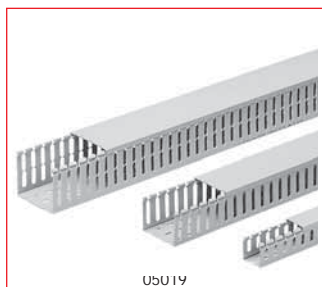

Standard; 8 – 12 mm slot, gray

| Dimensions W x H (mm) | Dimensions W x H (in) | Meters per package | Feet per package | Pieces per package ^① | Catalog number ^{①②} | List price per package | List price per 2M piece | List price per foot |
|-----------------------|-----------------------|--------------------|------------------|---------------------------------|------------------------------|------------------------|-------------------------|---------------------|
| 15 x 17 | 1/2 x 5/8 | 46 | 151 | 23 | 05019 | \$ 345.00 | \$ 15.00 | \$ 2.29 |
| 25 x 30 | 1 x 1 1/4 | 58 | 190.5 | 29 | 05033 | 565.50 | 19.50 | 2.97 |
| 40 x 30 | 1 1/2 x 1 3/4 | 40 | 131.5 | 20 | 05035 | 500.00 | 25.00 | 3.81 |
| 60 x 30 | 2 1/4 x 1 1/4 | 52 | 171 | 26 | 05037 | 734.50 | 28.25 | 4.31 |
| 25 x 40 | 1 x 1 1/2 | 48 | 157.5 | 24 | 05043 | 570.00 | 23.75 | 3.62 |
| 40 x 40 | 1 1/2 x 1 1/2 | 30 | 98.5 | 15 | 05045 | 397.50 | 26.50 | 4.04 |
| 60 x 40 | 2 1/4 x 1 1/2 | 40 | 131 | 20 | 05047 | 590.00 | 29.50 | 4.50 |
| 80 x 40 | 3 x 1 1/2 | 32 | 105 | 16 | 05049 | 604.00 | 37.75 | 5.75 |
| 100 x 40 | 4 x 1 1/2 | 24 | 79 | 12 | 05051 | 474.00 | 39.50 | 6.02 |
| 120 x 40 | 4 3/4 x 1 1/2 | 20 | 66 | 10 | 05053 | 432.50 | 43.25 | 6.59 |
| 25 x 60 | 1 x 2 1/4 | 34 | 111.5 | 17 | 05063 | 442.00 | 26.00 | 3.96 |
| 40 x 60 | 1 1/2 x 2 1/4 | 22 | 72 | 11 | 05065 | 319.00 | 29.00 | 4.42 |
| 60 x 60 | 2 1/4 x 2 1/4 | 32 | 105 | 16 | 05067 | 488.00 | 30.50 | 4.65 |
| 80 x 60 | 3 x 2 1/4 | 24 | 79 | 12 | 05069 | 468.00 | 39.00 | 5.94 |
| 100 x 60 | 4 x 2 1/4 | 20 | 66 | 10 | 05071 | 430.00 | 43.00 | 6.55 |
| 120 x 60 | 4 3/4 x 2 1/4 | 14 | 46 | 7 | 05073 | 343.00 | 49.00 | 7.47 |
| 25 x 80 | 1 x 3 | 28 | 92 | 14 | 05083 | 451.50 | 32.25 | 4.91 |
| 40 x 80 | 1 1/2 x 3 | 36 | 118 | 18 | 05085 | 634.50 | 35.25 | 5.37 |
| 60 x 80 | 2 1/4 x 3 | 24 | 79 | 12 | 05087 | 456.00 | 38.00 | 5.79 |
| 80 x 80 | 3 x 3 | 16 | 52 | 8 | 05089 | 364.00 | 45.50 | 6.93 |
| 100 x 80 | 4 x 3 | 16 | 52 | 8 | 05091 | 394.00 | 49.25 | 7.51 |
| 120 x 80 | 4 3/4 x 3 | 12 | 39 | 6 | 05093 | 336.00 | 56.00 | 8.53 |
| 25 x 100 | 1 x 4 | 20 | 65.5 | 10 | 05094 | 377.50 | 37.75 | 5.75 |
| 40 x 100 | 1 1/2 x 4 | 28 | 92 | 14 | 05095 | 567.00 | 40.50 | 6.17 |
| 60 x 100 | 2 1/4 x 4 | 20 | 66 | 10 | 05096 | 432.50 | 43.25 | 6.59 |
| 80 x 100 | 3 x 4 | 14 | 46 | 7 | 05097 | 371.00 | 53.00 | 8.08 |
| 100x 100 | 4 x 4 | 8 | 26 | 4 | 05098 | 236.00 | 59.00 | 8.99 |
| 150 x 100 | 6 x 4 | 8 | 26 | 4 | 05099 | 372.00 | 93.00 | 14.17 |

NOTE: Sold in package quantity only. Order quantity must equal quantity shown in "pieces per package" column.
Example: For 05019, 23 pieces must be ordered to get package quantity.

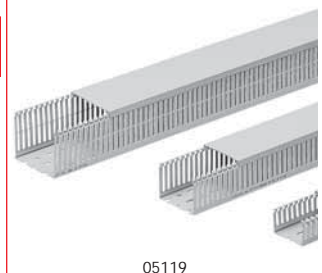

High density; 4 – 6 mm slot, gray

| Dimensions W x H (mm) | Dimensions W x H (in) | Meters per package | Feet per package | Pieces per package ^① | Catalog number ^{①②} | List price per package | List price per 2M piece | List price per foot |
|-----------------------|-----------------------|--------------------|------------------|---------------------------------|------------------------------|------------------------|-------------------------|---------------------|
| 15 x 17 | 1/2 x 5/8 | 46 | 151 | 23 | 05119 | \$ 345.00 | \$ 15.00 | \$ 2.29 |
| 25 x 30 | 1 x 1 1/4 | 58 | 190.5 | 29 | 05133 | 565.50 | 19.50 | 2.97 |
| 40 x 30 | 1 1/2 x 1 3/4 | 40 | 131.5 | 20 | 05135 | 500.00 | 25.00 | 3.81 |
| 60 x 30 | 2 1/4 x 1 1/4 | 52 | 171 | 26 | 05137 | 734.50 | 28.25 | 4.31 |
| 25 x 40 | 1 x 1 1/2 | 48 | 157.5 | 24 | 05143 | 570.00 | 23.75 | 3.62 |
| 40 x 40 | 1 1/2 x 1 1/2 | 30 | 98.5 | 15 | 05145 | 397.50 | 26.50 | 4.04 |
| 60 x 40 | 2 1/4 x 1 1/2 | 40 | 131 | 20 | 05147 | 590.00 | 29.50 | 4.50 |
| 80 x 40 | 3 x 1 1/2 | 32 | 105 | 16 | 05149 | 604.00 | 37.75 | 5.75 |
| 100 x 40 | 4 x 1 1/2 | 24 | 79 | 12 | 05151 | 474.00 | 39.50 | 6.02 |
| 120 x 40 | 4 3/4 x 1 1/2 | 20 | 66 | 10 | 05153 | 432.50 | 43.25 | 6.59 |
| 25 x 60 | 1 x 2 1/4 | 34 | 111.5 | 17 | 05163 | 442.00 | 26.00 | 3.96 |
| 40 x 60 | 1 1/2 x 2 1/4 | 22 | 72 | 11 | 05165 | 319.00 | 29.00 | 4.42 |
| 60 x 60 | 2 1/4 x 2 1/4 | 32 | 105 | 16 | 05167 | 488.00 | 30.50 | 4.65 |
| 80 x 60 | 3 x 2 1/4 | 24 | 79 | 12 | 05169 | 468.00 | 39.00 | 5.94 |
| 100 x 60 | 4 x 2 1/4 | 20 | 66 | 10 | 05171 | 430.00 | 43.00 | 6.55 |
| 120 x 60 | 4 3/4 x 2 1/4 | 14 | 46 | 7 | 05173 | 343.00 | 49.00 | 7.47 |
| 25 x 80 | 1 x 3 | 28 | 92 | 14 | 05183 | 451.50 | 32.25 | 4.91 |
| 40 x 80 | 1 1/2 x 3 | 36 | 118 | 18 | 05185 | 634.50 | 35.25 | 5.37 |
| 60 x 80 | 2 1/4 x 3 | 24 | 79 | 12 | 05187 | 456.00 | 38.00 | 5.79 |
| 80 x 80 | 3 x 3 | 16 | 52 | 8 | 05189 | 364.00 | 45.50 | 6.93 |
| 100 x 80 | 4 x 3 | 16 | 52 | 8 | 05191 | 394.00 | 49.25 | 7.51 |
| 120 x 80 | 4 3/4 x 3 | 12 | 39 | 6 | 05193 | 336.00 | 56.00 | 8.53 |
| 25 x 100 | 1 x 4 | 20 | 65.5 | 10 | 05194 | 377.50 | 37.75 | 5.75 |
| 40 x 100 | 1 1/2 x 4 | 28 | 92 | 14 | 05195 | 567.00 | 40.50 | 6.17 |
| 60 x 100 | 2 1/4 x 4 | 20 | 66 | 10 | 05196 | 432.50 | 43.25 | 6.59 |
| 80 x 100 | 3 x 4 | 14 | 46 | 7 | 05197 | 371.00 | 53.00 | 8.08 |
| 100x 100 | 4 x 4 | 8 | 26 | 4 | 05198 | 236.00 | 59.00 | 8.99 |
| 150 x 100 | 6 x 4 | 8 | 26 | 4 | 05199 | 372.00 | 93.00 | 14.17 |

NOTE: Sold in package quantity only. Order quantity must equal quantity shown in "pieces per package" column.
Example: For 05119, 23 pieces must be ordered to get package quantity.

① Sold in package quantity only. Order quantity must equal quantity shown in "pieces per package" column.
② Wire duct cover included.

Wiring duct, white

Standard; 8 – 12mm slot
High density; 4 – 6mm slot

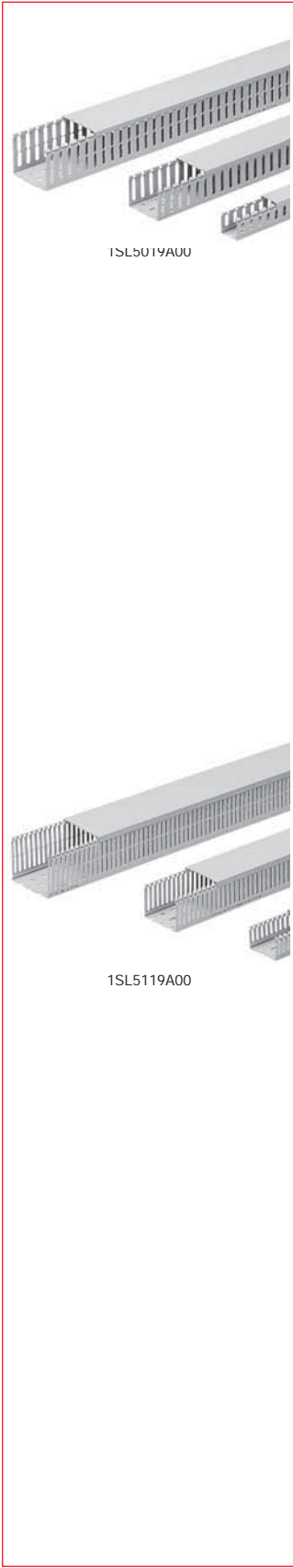

Standard; 8 – 12 mm slot

| Dimensions W x H (mm) | Dimensions W x H (in) | Meters per package | Feet per package | Pieces per package ^① | Catalog number ^{①②} | List price per package | List price per 2M piece | List price per foot |
|-----------------------|-----------------------|--------------------|------------------|---------------------------------|------------------------------|------------------------|-------------------------|---------------------|
| 15 x 17 | 1/2 x 5/8 | 46 | 151 | 23 | 1SL5019A00 | \$ 345.00 | \$ 15.00 | \$ 2.29 |
| 25 x 30 | 1 x 1 1/4 | 58 | 190.5 | 29 | 1SL5033A00 | 565.50 | 19.50 | 2.97 |
| 40 x 30 | 1 1/2 x 1 3/4 | 40 | 131.5 | 20 | 1SL5035A00 | 500.00 | 25.00 | 3.81 |
| 60 x 30 | 2 1/4 x 1 1/4 | 52 | 171 | 26 | 1SL5037A00 | 734.50 | 28.25 | 4.31 |
| 25 x 40 | 1 x 1 1/2 | 48 | 157.5 | 24 | 1SL5043A00 | 570.00 | 23.75 | 3.62 |
| 40 x 40 | 1 1/2 x 1 1/2 | 30 | 98.5 | 15 | 1SL5045A00 | 397.50 | 26.50 | 4.04 |
| 60 x 40 | 2 1/4 x 1 1/2 | 40 | 131 | 20 | 1SL5047A00 | 590.00 | 29.50 | 4.50 |
| 80 x 40 | 3 x 1 1/2 | 32 | 105 | 16 | 1SL5049A00 | 604.00 | 37.75 | 5.75 |
| 100 x 40 | 4 x 1 1/2 | 24 | 79 | 12 | 1SL5051A00 | 474.00 | 39.50 | 6.02 |
| 120 x 40 | 4 3/4 x 1 1/2 | 20 | 66 | 10 | 1SL5053A00 | 432.50 | 43.25 | 6.59 |
| 25 x 60 | 1 x 2 1/4 | 34 | 111.5 | 17 | 1SL5063A00 | 442.00 | 26.00 | 3.96 |
| 40 x 60 | 1 1/2 x 2 1/4 | 22 | 72 | 11 | 1SL5065A00 | 319.00 | 29.00 | 4.42 |
| 60 x 60 | 2 1/4 x 2 1/4 | 32 | 105 | 16 | 1SL5067A00 | 488.00 | 30.50 | 4.65 |
| 80 x 60 | 3 x 2 1/4 | 24 | 79 | 12 | 1SL5069A00 | 468.00 | 39.00 | 5.94 |
| 100 x 60 | 4 x 2 1/4 | 20 | 66 | 10 | 1SL5071A00 | 430.00 | 43.00 | 6.55 |
| 120 x 60 | 4 3/4 x 2 1/4 | 14 | 46 | 7 | 1SL5073A00 | 343.00 | 49.00 | 7.47 |
| 25 x 80 | 1 x 3 | 28 | 92 | 14 | 1SL5083A00 | 451.50 | 32.25 | 4.91 |
| 40 x 80 | 1 1/2 x 3 | 36 | 118 | 18 | 1SL5085A00 | 634.50 | 35.25 | 5.37 |
| 60 x 80 | 2 1/4 x 3 | 24 | 79 | 12 | 1SL5087A00 | 456.00 | 38.00 | 5.79 |
| 80 x 80 | 3 x 3 | 16 | 52 | 8 | 1SL5089A00 | 364.00 | 45.50 | 6.93 |
| 100 x 80 | 4 x 3 | 16 | 52 | 8 | 1SL5091A00 | 394.00 | 49.25 | 7.51 |
| 120 x 80 | 4 3/4 x 3 | 12 | 39 | 6 | 1SL5093A00 | 336.00 | 56.00 | 8.53 |
| 25 x 100 | 1 x 4 | 20 | 65.5 | 10 | 1SL5094A00 | 377.50 | 37.75 | 5.75 |
| 40 x 100 | 1 1/2 x 4 | 28 | 92 | 14 | 1SL5095A00 | 567.00 | 40.50 | 6.17 |
| 60 x 100 | 2 1/4 x 4 | 20 | 66 | 10 | 1SL5096A00 | 432.50 | 43.25 | 6.59 |
| 80 x 100 | 3 x 4 | 14 | 46 | 7 | 1SL5097A00 | 371.00 | 53.00 | 8.08 |
| 100 x 100 | 4 x 4 | 8 | 26 | 4 | 1SL5098A00 | 236.00 | 59.00 | 8.99 |
| 150 x 100 | 6 x 4 | 8 | 26 | 4 | 1SL5099A00 | 372.00 | 93.00 | 14.17 |

NOTE: Sold in package quantity only. Order quantity must equal quantity shown in "pieces per package" column. Example: For 1SL5019A00, 23 pieces must be ordered to get package quantity.

High density; 4 – 6 mm slot

| Dimensions W x H (mm) | Dimensions W x H (in) | Meters per package | Feet per package | Pieces per package ^① | Catalog number ^{①②} | List price per package | List price per 2M piece | List price per foot |
|-----------------------|-----------------------|--------------------|------------------|---------------------------------|------------------------------|------------------------|-------------------------|---------------------|
| 15 x 17 | 1/2 x 5/8 | 46 | 151 | 23 | 1SL5119A00 | \$ 345.00 | \$ 15.00 | \$ 2.29 |
| 25 x 30 | 1 x 1 1/4 | 58 | 190.5 | 29 | 1SL5133A00 | 565.50 | 19.50 | 2.97 |
| 40 x 30 | 1 1/2 x 1 3/4 | 40 | 131.5 | 20 | 1SL5135A00 | 500.00 | 25.00 | 3.81 |
| 60 x 30 | 2 1/4 x 1 1/4 | 52 | 171 | 26 | 1SL5137A00 | 734.50 | 28.25 | 4.31 |
| 25 x 40 | 1 x 1 1/2 | 48 | 157.5 | 24 | 1SL5143A00 | 570.00 | 23.75 | 3.62 |
| 40 x 40 | 1 1/2 x 1 1/2 | 30 | 98.5 | 15 | 1SL5145A00 | 397.50 | 26.50 | 4.04 |
| 60 x 40 | 2 1/4 x 1 1/2 | 40 | 131 | 20 | 1SL5147A00 | 590.00 | 29.50 | 4.50 |
| 80 x 40 | 3 x 1 1/2 | 32 | 105 | 16 | 1SL5149A00 | 604.00 | 37.75 | 5.75 |
| 100 x 40 | 4 x 1 1/2 | 24 | 79 | 12 | 1SL5151A00 | 474.00 | 39.50 | 6.02 |
| 120 x 40 | 4 3/4 x 1 1/2 | 20 | 66 | 10 | 1SL5153A00 | 432.50 | 43.25 | 6.59 |
| 25 x 60 | 1 x 2 1/4 | 34 | 111.5 | 17 | 1SL5163A00 | 442.00 | 26.00 | 3.96 |
| 40 x 60 | 1 1/2 x 2 1/4 | 22 | 72 | 11 | 1SL5165A00 | 319.00 | 29.00 | 4.42 |
| 60 x 60 | 2 1/4 x 2 1/4 | 32 | 105 | 16 | 1SL5167A00 | 488.00 | 30.50 | 4.65 |
| 80 x 60 | 3 x 2 1/4 | 24 | 79 | 12 | 1SL5169A00 | 468.00 | 39.00 | 5.94 |
| 100 x 60 | 4 x 2 1/4 | 20 | 66 | 10 | 1SL5171A00 | 430.00 | 43.00 | 6.55 |
| 120 x 60 | 4 3/4 x 2 1/4 | 14 | 46 | 7 | 1SL5173A00 | 343.00 | 49.00 | 7.47 |
| 25 x 80 | 1 x 3 | 28 | 82 | 14 | 1SL5183A00 | 451.50 | 32.25 | 4.91 |
| 40 x 80 | 1 1/2 x 3 | 36 | 118 | 18 | 1SL5185A00 | 634.50 | 35.25 | 5.37 |
| 60 x 80 | 2 1/4 x 3 | 24 | 79 | 12 | 1SL5187A00 | 456.00 | 38.00 | 5.79 |
| 80 x 80 | 3 x 3 | 16 | 52 | 8 | 1SL5189A00 | 364.00 | 45.50 | 6.93 |
| 100 x 80 | 4 x 3 | 16 | 52 | 8 | 1SL5191A00 | 394.00 | 49.25 | 7.51 |
| 120 x 80 | 4 3/4 x 3 | 12 | 39 | 6 | 1SL5193A00 | 336.00 | 56.00 | 8.53 |
| 25 x 100 | 1 x 4 | 20 | 65.5 | 10 | 1SL5194A00 | 377.50 | 37.75 | 5.75 |
| 40 x 100 | 1 1/2 x 4 | 28 | 92 | 14 | 1SL5195A00 | 567.00 | 40.50 | 6.17 |
| 60 x 100 | 2 1/4 x 4 | 20 | 66 | 10 | 1SL5196A00 | 432.50 | 43.25 | 6.59 |
| 80 x 100 | 3 x 4 | 14 | 46 | 7 | 1SL5197A00 | 371.00 | 53.00 | 8.08 |
| 100x 100 | 4 x 4 | 8 | 26 | 4 | 1SL5198A00 | 236.00 | 59.00 | 8.99 |
| 150 x 100 | 6 x 4 | 8 | 26 | 4 | 1SL5199A00 | 372.00 | 93.00 | 14.17 |

NOTE: Sold in package quantity only. Order quantity must equal quantity shown in "pieces per package" column. Example: For 1SL5119A00, 23 pieces must be ordered to get package quantity.

① Sold in package quantity only. Order quantity must equal quantity shown in "pieces per package" column.
② Wire duct cover included.

Wiring duct Specialty products

Wiring duct with knockouts

Wiring duct with 18mm 1/2" and 23mm 3/4" knockouts, gray

| Dimensions W x H (mm) | Dimensions W x H (in) | Meters per package | Feet per package | Pieces per package ① | Catalog number ①② | List price per package ① | List price per 2M piece | List price per foot |
|--------------------------|--------------------------|-----------------------|---------------------|-------------------------|----------------------|-----------------------------|----------------------------|------------------------|
| 50 x 50 | 2 x 2 | 36 | 118 | 18 | 05330 | \$ 738.00 | \$ 41.00 | \$ 6.25 |
| 100 x 60 | 4 x 1 1/2 | 18 | 59 | 9 | 05331 | 450.00 | 45.00 | 7.50 |

NOTE: Sold in package quantity only. Order quantity must equal quantity shown in "pieces per package" column.
Example: For 05330, 18 pieces must be ordered to get package quantity.

Flexible wiring duct

Flexible wiring duct – (500mm), White

| Dimensions W x H (mm) | Dimensions W x H (in) | Meters per package | Feet per package | Pieces per ① | Catalog number ① | List price per package | List price per piece | List price per foot |
|--------------------------|--------------------------|-----------------------|---------------------|--------------|---------------------|---------------------------|-------------------------|------------------------|
| 12.5 x 12.5 | 1/2 x 1/2 | 56 | 184 | 112 | 05400 | \$ 1344.00 | \$ 12.00 | \$ 7.32 |
| 16 x 16 | 5/8 x 5/8 | 42 | 138 | 84 | 05402 | 1134.00 | 13.50 | 8.23 |
| 20 x 20 | 3/4 x 3/4 | 56 | 184 | 112 | 05405 | 1820.00 | 16.25 | 9.91 |
| 25 x 25 | 1 x 1 | 35 | 115 | 70 | 05410 | 1260.00 | 18.00 | 10.97 |
| 30 x 30 | 1 3/4 x 1 3/4 | 25 | 82 | 50 | 05415 | 1075.00 | 21.50 | 13.11 |
| 40 x 40 | 1 1/2 x 1 1/2 | 25 | 82 | 50 | 05420 | 1375.00 | 27.50 | 16.76 |
| 50 x 50 | 2 x 2 | 16 | 52 | 32 | 05425 | 1064.00 | 33.25 | 20.27 |

NOTE: Sold in package quantity only. Order quantity must equal quantity shown in "pieces per package" column.
Example: For 05400, 112 pieces must be ordered to get package quantity.

Flexible wiring duct – UL Recognized (19.5"), Gray

| Dimensions Inside dia. (mm) | Dimensions Inside dia. (in.) | Meters per package | Feet per package | Pieces per package | Catalog number | List price per package | List price per piece | List price per foot |
|--------------------------------|---------------------------------|-----------------------|---------------------|-----------------------|-------------------|---------------------------|-------------------------|------------------------|
| 10 | .39 | 350 | 1148 | 700 | T-10 ③ | \$ 7700.00 | \$ 11.00 | \$ 6.77 |
| 20 | .79 | 175 | 574 | 350 | T-20 ③ | 4112.50 | 11.75 | 7.23 |
| 30 | 1.18 | 100 | 328 | 200 | T-30 ③ | 2550.00 | 12.75 | 7.85 |
| 40 | 1.58 | 50 | 164 | 100 | T-40 ③ | 1450.00 | 14.50 | 8.92 |

Spiral wrap

Spiral wrap

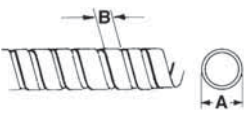
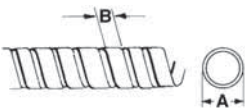
| Height Dim A in [mm] | Width Dim B in [mm] | Diameter (mm) | | Length per roll (meters) | Length per roll (feet) | Catalog number | List price | |
|--|---------------------------|-----------------|-----------------|--|---------------------------|-------------------|---------------|----------|
| | | Min. in [mm] | Max. in [mm] | | | | | |
| Translucent polyethylene | | | | | | | | |
| .12 [3] | .2 [5] | .08 [2] | .47 [12] |  | 50 | 164 | 18370 | \$ 60.00 |
| .24 [6] | .31 [8] | .2 [5] | 2.20 [56] | | 25 | 82 | 18372 | 40.75 |
| .39 [10] | .43 [11] | .47 [12] | 3.94 [100] | | 25 | 82 | 18374 | 56.50 |
| .47 [12] | .51 [13] | .55 [14] | 5.12 [130] | | 25 | 82 | 18376 | 92.00 |
| Self-extinguishing polyethylene | | | | | | | | |
| .12 [3] | .2 [5] | .08 [2] | .47 [12] |  | 50 | 164 | 18380 | 70.00 |
| .24 [6] | .31 [8] | .2 [5] | 2.20 [56] | | 25 | 82 | 18382 | 52.50 |
| .39 [10] | .43 [11] | .47 [12] | 3.94 [100] | | 25 | 82 | 18384 | 84.00 |
| .47 [12] | .51 [13] | .55 [14] | 5.12 [130] | | 25 | 82 | 18386 | 117.25 |

① Sold in package quantity only. Order quantity must equal quantity shown in "pieces per package" column.

② Wire duct cover included.

③ T10 has a square body; T20 - T40 has a round body.

Wiring duct Tools and Accessories

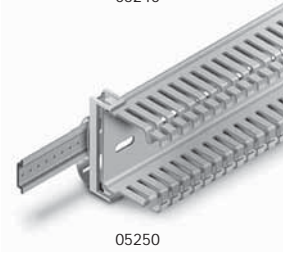
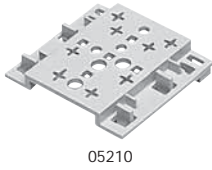

| Item | Pieces per package | Catalog number | List price per package |
|---|--------------------|----------------|------------------------|
| Plastic rivet, 4 mm (to be used with plastic ducting base) | 100 | 05214 | \$ 30 |
| Plastic rivet, 6 mm, (to be used with plastic ducting base) | 100 | 05216 | 36 |
| Plastic ducting base | 100 | 05210 | 150 |
| Plastic wire stops for 8 - 12 mm slot 40 mm bases | 100 | 05224 | 100 |
| Plastic wire stops for 8 - 12 mm slot 60 mm bases | 100 | 05226 | 125 |
| Plastic wire stops for 8 - 12 mm slot 80 mm bases | 100 | 05228 | 150 |
| Plastic wire stops for 8 - 12 mm slot 100 mm bases | 100 | 05230 | 200 |
| Plastic label for 8 - 12 mm slot | 100 | 05240 | 240 |
| Rapid clip for DIN rail for 25 mm base | 20 | 05250 | 100 |
| Rapid clip for DIN rail for 40 mm base | 20 | 05252 | 80 |
| Rapid clip for DIN rail for 60 mm base | 20 | 05254 | 90 |
| Rapid clip for DIN rail for 80 mm base | 20 | 05256 | 100 |
| Rapid clip for DIN rail for 100 mm base | 20 | 05258 | 105 |
| Rapid clip for DIN rail for 120 mm base | 20 | 05260 | 110 |
| Rapid clip for DIN rail for 150 mm base | 20 | 05262 | 115 |
| Wire duct hand cutting tool | 1 | 05265 | 150 |
| Rivet gun | 1 | 05266 | 200 |
| Adhesive tape, 6 mm wide x 50 m long | 1 | 05930 | 65 |
| Adhesive tape, 9 mm wide x 50 m long | 1 | 05932 | 95 |

Wiring duct covers

| Dimensions Width mm | Color | Meters per package | Feet per package | Pieces per package | Catalog number | List price per package | List price per 2M piece | List price per foot |
|---------------------|-------|--------------------|------------------|--------------------|----------------|------------------------|-------------------------|---------------------|
| 15 | Gray | 200 | 656 | 100 | 05300 | \$ 400.00 | \$ 4.00 | \$ 0.61 |
| 25 | Gray | 60 | 197 | 30 | 05302 | 144.00 | 4.80 | 0.73 |
| 40 | Gray | 40 | 131 | 20 | 05304 | 170.00 | 8.50 | 1.30 |
| 60 | Gray | 24 | 79 | 12 | 05306 | 159.00 | 13.25 | 2.02 |
| 80 | Gray | 16 | 52 | 8 | 05308 | 164.00 | 20.50 | 3.12 |
| 100 | Gray | 48 | 157 | 24 | 05310 | 576.00 | 24.00 | 3.66 |
| 120 | Gray | 36 | 118 | 18 | 05312 | 621.00 | 34.50 | 5.26 |
| 150 | Gray | 28 | 92 | 14 | 05314 | 637.00 | 45.50 | 6.93 |
| 15 | White | 200 | 656 | 100 | 1SL5300A00 | 400.00 | 4.00 | 0.61 |
| 25 | White | 60 | 197 | 30 | 1SL5302A00 | 144.00 | 4.80 | 0.73 |
| 40 | White | 40 | 131 | 20 | 1SL5304A00 | 170.00 | 8.50 | 1.30 |
| 60 | White | 24 | 79 | 12 | 1SL5306A00 | 159.00 | 13.25 | 2.02 |
| 80 | White | 16 | 52 | 8 | 1SL5308A00 | 164.00 | 20.50 | 3.12 |
| 100 | White | 48 | 157 | 24 | 1SL5310A00 | 576.00 | 24.00 | 3.66 |
| 120 | White | 36 | 118 | 18 | 1SL5312A00 | 621.00 | 34.50 | 5.26 |
| 150 | White | 28 | 92 | 14 | 1SL5314A00 | 637.00 | 45.50 | 6.93 |

NOTE: Sold in package quantity only. Order quantity must equal quantity shown in "pieces per package" column.
Example: For 05300, 100 pieces must be ordered to get package quantity.

Wiring duct Tools Wiring duct cutter – Industrial grade

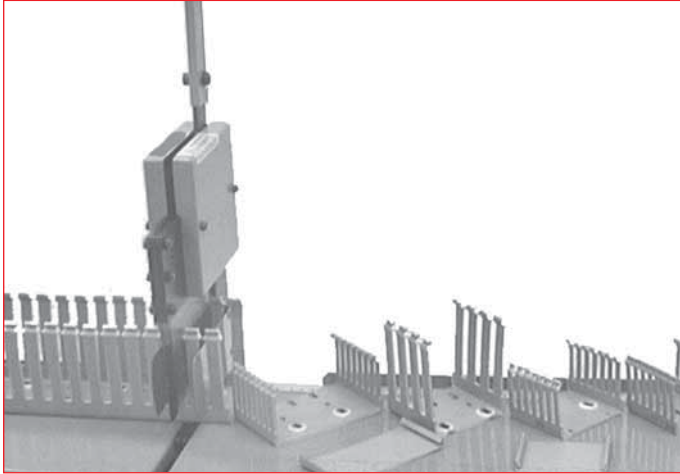

Description

| Description | Catalog number | List price |
|--|----------------|------------|
| Wire duct cutting machine - Industrial grade | XUS001628 | \$ 800 |
| Replacement blade | XUS001629 | 300 |

Technical Features

- Length: 1450 mm
- Height: 950 mm
- Depth: 260 mm
- Blade length: 130 mm (maximum wire duct cutting width is 120 mm (5.0 in))
- Blade life: 250,000 cuts
- Blade life is based on usage of traditional PVC wiring duct. Use of halogen-free wiring or any other wiring duct containing abrasive material dramatically reduces the blade life
- Bench mounting material not included.

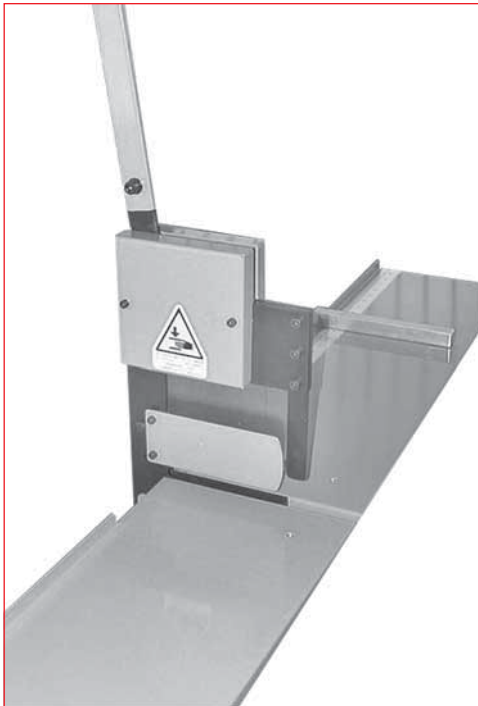

13

Wiring duct

Tools

Wiring duct cutter – Production grade



Description

| Description | Catalog number | List price |
|--|----------------|------------|
| Wire duct cutting machine - Production grade | XUS002518 | \$ 1200 |
| Replacement blade | XUS002519 | 495 |

Technical Features

- Length: 1290 mm
- Height: 785 mm
- Depth: 285 mm
- Blade length: 136 mm (maximum wire duct cutting width is 120 mm (5.0 in))
- Blade life: 400,000 cuts
- Blade life is based on usage of traditional PVC wiring duct. Use of halogen-free wiring or any other wiring duct containing abrasive material dramatically reduces the blade life
- Calibrated scale
- Bench mounting material not included.

Wiring duct

Technical data

Wire capacity, 18 - 750 AWG

18 - 1 AWG

| Gray 4/6 slot | Gray 8/12 slot | ABB wiring duct code | | Nominal duct size (mm) | Nominal duct size (inches) | Usable areas (mm ²) | Maximum number of wires according to AGW and cable section (mm ²) | | | | | | | | | | | | | |
|------------------|-------------------|----------------------|--------------------|------------------------------|----------------------------------|---------------------------------------|---|-----------|-----------|-----------|-----------|----------|-----------|-----------|-----------|-----------|-----------|--|--|--|
| | | White 4/6 slot | White 8/12 slot | | | | 18 0.82 | 16 1.3 | 14 2.1 | 12 3.3 | 10 5.3 | 8 8.4 | 6 13.3 | 4 21.2 | 3 26.7 | 2 33.6 | 1 42.4 | | | |
| 05119 | 05019 | 1SL5119A00 | 1SL5019A00 | 15x17 | 1/2x5/8 | 110 | 67 | 42 | 26 | 16 | 10 | 6 | 4 | 2 | 2 | 1 | 1 | | | |
| 05133 | 05033 | 1SL5133A00 | 1SL5033A00 | 25x30 | 1x1 1/4 | 490 | 298 | 188 | 116 | 74 | 46 | 29 | 18 | 11 | 9 | 7 | 5 | | | |
| 05135 | 05035 | 1SL5135A00 | 1SL5035A00 | 40X30 | 1 1/2X1 1/4 | 890 | 542 | 342 | 211 | 134 | 83 | 52 | 33 | 20 | 16 | 13 | 10 | | | |
| 05137 | 05037 | 1SL5137A00 | 1SL5037A00 | 60x30 | 2 1/4X1 1/4 | 1430 | 871 | 550 | 340 | 216 | 134 | 85 | 53 | 33 | 26 | 21 | 16 | | | |
| 05143 | 05043 | 1SL5143A00 | 1SL5043A00 | 25X40 | 1X1 1/2 | 710 | 432 | 273 | 169 | 107 | 66 | 42 | 26 | 16 | 13 | 10 | 8 | | | |
| 05145 | 05045 | 1SL5145A00 | 1SL5045A00 | 40x40 | 1 1/2x1 1/2 | 1260 | 768 | 484 | 300 | 190 | 118 | 75 | 47 | 29 | 23 | 18 | 14 | | | |
| 05147 | 05047 | 1SL5147A00 | 1SL5047A00 | 60x40 | 2 1/4x1 1/2 | 2000 | 1219 | 769 | 476 | 303 | 188 | 119 | 75 | 47 | 37 | 29 | 23 | | | |
| 05149 | 05049 | 1SL5149A00 | 1SL5049A00 | 80X40 | 3X1 1/2 | 2710 | 1652 | 1042 | 645 | 410 | 255 | 161 | 101 | 63 | 50 | 40 | 31 | | | |
| 05151 | 05051 | 1SL5151A00 | 1SL5051A00 | 100X40 | 4X1 1/2 | 3460 | 2109 | 1330 | 823 | 524 | 326 | 205 | 130 | 81 | 64 | 51 | 40 | | | |
| 05153 | 05053 | 1SL5153A00 | 1SL5053A00 | 120X40 | 4 3/4X1 1/2 | 4200 | 2560 | 1615 | 1000 | 636 | 396 | 250 | 157 | 99 | 78 | 62 | 49 | | | |
| 05163 | 05063 | 1SL5163A00 | 1SL5063A00 | 25X60 | 1 X 2 1/4 | 1120 | 682 | 430 | 266 | 169 | 105 | 66 | 42 | 26 | 20 | 16 | 13 | | | |
| 05165 | 05065 | 1SL5165A00 | 1SL5065A00 | 40X60 | 1 1/2X2 1/4 | 1970 | 1201 | 757 | 469 | 298 | 185 | 117 | 74 | 46 | 36 | 29 | 23 | | | |
| 05167 | 05067 | 1SL5167A00 | 1SL5067A00 | 60X60 | 2 1/4X2 1/4 | 3060 | 1865 | 1176 | 728 | 463 | 288 | 182 | 115 | 72 | 57 | 45 | 36 | | | |
| 05169 | 05069 | 1SL5169A00 | 1SL5069A00 | 80X60 | 3X2 1/4 | 4190 | 2554 | 1611 | 997 | 634 | 395 | 249 | 157 | 98 | 78 | 62 | 49 | | | |
| 05171 | 05071 | 1SL5171A00 | 1SL5071A00 | 100X60 | 4X2 1/4 | 5320 | 3243 | 2046 | 1266 | 806 | 501 | 316 | 200 | 125 | 99 | 79 | 62 | | | |
| 05173 | 05073 | 1SL5173A00 | 1SL5073A00 | 120X60 | 4 3/4X2 1/4 | 6330 | 3859 | 2434 | 1507 | 959 | 597 | 376 | 237 | 149 | 118 | 94 | 74 | | | |
| 05183 | 05083 | 1SL5183A00 | 1SL5083A00 | 25X80 | 1X3 | 1540 | 939 | 592 | 366 | 233 | 145 | 91 | 57 | 36 | 28 | 22 | 18 | | | |
| 05185 | 05085 | 1SL5185A00 | 1SL5085A00 | 40X80 | 1 1/2X3 | 2670 | 1628 | 1026 | 635 | 404 | 251 | 158 | 100 | 62 | 50 | 39 | 31 | | | |
| 05187 | 05087 | 1SL5187A00 | 1SL5087A00 | 60X80 | 2 1/4X3 | 4140 | 2524 | 1592 | 985 | 627 | 390 | 246 | 155 | 97 | 77 | 61 | 48 | | | |
| 05189 | 05089 | 1SL5189A00 | 1SL5089A00 | 80X80 | 3X3 | 5650 | 3445 | 2173 | 1345 | 856 | 533 | 336 | 212 | 133 | 105 | 84 | 66 | | | |
| 05191 | 05091 | 1SL5191A00 | 1SL5091A00 | 100X80 | 4X3 | 7170 | 4371 | 2757 | 1707 | 1086 | 676 | 426 | 269 | 169 | 134 | 106 | 84 | | | |
| 05193 | 05093 | 1SL5193A00 | 1SL5093A00 | 120X80 | 4 3/4X3 | 8570 | 5225 | 3296 | 2040 | 1298 | 808 | 510 | 322 | 202 | 160 | 127 | 101 | | | |
| 05194 | 05094 | 1SL5194A00 | 1SL5094A00 | 25X100 | 1X4 | 1970 | 1201 | 757 | 469 | 298 | 185 | 117 | 74 | 46 | 36 | 29 | 23 | | | |
| 05195 | 05095 | 1SL5195A00 | 1SL5095A00 | 40X100 | 1 1/2X4 | 3410 | 2079 | 1311 | 811 | 516 | 321 | 202 | 128 | 80 | 63 | 50 | 40 | | | |
| 05196 | 05096 | 1SL5196A00 | 1SL5096A00 | 60X100 | 2 1/4X4 | 5300 | 3231 | 2038 | 1261 | 803 | 500 | 315 | 199 | 125 | 99 | 78 | 62 | | | |
| 05197 | 05097 | 1SL5197A00 | 1SL5097A00 | 80X100 | 3X4 | 7190 | 4384 | 2765 | 1711 | 1089 | 678 | 427 | 270 | 169 | 134 | 106 | 84 | | | |
| 05198 | 05098 | 1SL5198A00 | 1SL5098A00 | 100X100 | 4X4 | 9110 | 5554 | 3503 | 2169 | 1380 | 859 | 542 | 342 | 214 | 170 | 135 | 107 | | | |
| 05199 | 05099 | 1SL5199A00 | 1SL5099A00 | 150X100 | 6X4 | 13,740 | 8378 | 5284 | 3271 | 2081 | 1296 | 817 | 516 | 324 | 257 | 204 | 162 | | | |

1/0 - 750 AWG

13

| Gray 4/6 slot | Gray 8/12 slot | ABB wiring duct code | | Nominal duct size (mm) | Nominal duct size (inches) | Usable areas (mm ²) | Maximum number of wires according to AGW and cable section (mm ²) | | | | | | | | | | | | | |
|------------------|-------------------|----------------------|--------------------|------------------------------|----------------------------------|---------------------------------------|---|-------------|-----------|--------------|------------|------------|------------|------------|------------|------------|------------|--|--|--|
| | | White 4/6 slot | White 8/12 slot | | | | 1/0 53.5 | 2/0 67.4 | 3/0 85 | 4/0 107.2 | 250 127 | 300 152 | 350 177 | 400 203 | 500 253 | 600 304 | 750 380 | | | |
| 05119 | 05019 | 1SL5119A00 | 1SL5019A00 | 15x17 | 1/2x5/8 | 110 | 1 | 0 | 0 | 0 | 0 | 0 | 0 | 0 | 0 | 0 | 0 | | | |
| 05133 | 05033 | 1SL5133A00 | 1SL5033A00 | 25x30 | 1x1 1/4 | 490 | 4 | 3 | 2 | 2 | 1 | 1 | 1 | 1 | 0 | 0 | 0 | | | |
| 05135 | 05035 | 1SL5135A00 | 1SL5035A00 | 40X30 | 1 1/2X1 1/4 | 890 | 8 | 6 | 5 | 4 | 3 | 2 | 2 | 2 | 1 | 1 | 1 | | | |
| 05137 | 05037 | 1SL5137A00 | 1SL5037A00 | 60x30 | 2 1/4X1 1/4 | 1430 | 13 | 10 | 8 | 6 | 5 | 4 | 4 | 3 | 2 | 2 | 1 | | | |
| 05143 | 05043 | 1SL5143A00 | 1SL5043A00 | 25X40 | 1X1 1/2 | 710 | 6 | 5 | 4 | 3 | 2 | 2 | 2 | 1 | 1 | 1 | 0 | | | |
| 05145 | 05045 | 1SL5145A00 | 1SL5045A00 | 40x40 | 1 1/2x1 1/2 | 1260 | 11 | 9 | 7 | 5 | 4 | 4 | 3 | 3 | 2 | 2 | 1 | | | |
| 05147 | 05047 | 1SL5147A00 | 1SL5047A00 | 60x40 | 2 1/4x1 1/2 | 2000 | 18 | 14 | 11 | 9 | 7 | 6 | 5 | 4 | 3 | 3 | 2 | | | |
| 05149 | 05049 | 1SL5149A00 | 1SL5049A00 | 80X40 | 3X1 1/2 | 2710 | 25 | 20 | 15 | 12 | 10 | 8 | 7 | 6 | 5 | 4 | 3 | | | |
| 05151 | 05051 | 1SL5151A00 | 1SL5051A00 | 100X40 | 4X1 1/2 | 3460 | 32 | 25 | 20 | 16 | 13 | 11 | 9 | 8 | 6 | 5 | 4 | | | |
| 05153 | 05053 | 1SL5153A00 | 1SL5053A00 | 120X40 | 4 3/4X1 1/2 | 4200 | 39 | 31 | 24 | 19 | 16 | 13 | 11 | 10 | 8 | 6 | 5 | | | |
| 05163 | 05063 | 1SL5163A00 | 1SL5063A00 | 25X60 | 1 X 2 1/4 | 1120 | 10 | 8 | 6 | 5 | 4 | 3 | 3 | 2 | 2 | 1 | 1 | | | |
| 05165 | 05065 | 1SL5165A00 | 1SL5065A00 | 40X60 | 1 1/2X2 1/4 | 1970 | 18 | 14 | 11 | 9 | 7 | 6 | 5 | 4 | 3 | 3 | 2 | | | |
| 05167 | 05067 | 1SL5167A00 | 1SL5067A00 | 60X60 | 2 1/4X2 1/4 | 3060 | 28 | 22 | 18 | 14 | 12 | 10 | 8 | 7 | 6 | 5 | 4 | | | |
| 05169 | 05069 | 1SL5169A00 | 1SL5069A00 | 80X60 | 3X2 1/4 | 4190 | 39 | 31 | 24 | 19 | 16 | 13 | 11 | 10 | 8 | 6 | 5 | | | |
| 05171 | 05071 | 1SL5171A00 | 1SL5071A00 | 100X60 | 4X2 1/4 | 5320 | 49 | 39 | 31 | 24 | 20 | 17 | 15 | 13 | 10 | 8 | 7 | | | |
| 05173 | 05073 | 1SL5173A00 | 1SL5073A00 | 120X60 | 4 3/4X2 1/4 | 6330 | 59 | 46 | 37 | 29 | 24 | 20 | 17 | 15 | 12 | 10 | 8 | | | |
| 05183 | 05083 | 1SL5183A00 | 1SL5083A00 | 25X80 | 1X3 | 1540 | 14 | 11 | 9 | 7 | 6 | 5 | 4 | 3 | 3 | 2 | 2 | | | |
| 05185 | 05085 | 1SL5185A00 | 1SL5085A00 | 40X80 | 1 1/2X3 | 2670 | 24 | 19 | 15 | 12 | 10 | 8 | 7 | 6 | 5 | 4 | 3 | | | |
| 05187 | 05087 | 1SL5187A00 | 1SL5087A00 | 60X80 | 2 1/4X3 | 4140 | 38 | 30 | 24 | 19 | 16 | 13 | 11 | 10 | 8 | 6 | 5 | | | |
| 05189 | 05089 | 1SL5189A00 | 1SL5089A00 | 80X80 | 3X3 | 5650 | 52 | 41 | 33 | 26 | 22 | 18 | 15 | 13 | 11 | 9 | 7 | | | |
| 05191 | 05091 | 1SL5191A00 | 1SL5091A00 | 100X80 | 4X3 | 7170 | 67 | 53 | 42 | 33 | 28 | 23 | 20 | 17 | 14 | 11 | 9 | | | |
| 05193 | 05093 | 1SL5193A00 | 1SL5093A00 | 120X80 | 4 3/4X3 | 8570 | 80 | 63 | 50 | 39 | 33 | 28 | 24 | 21 | 16 | 14 | 11 | | | |
| 05194 | 05094 | 1SL5194A00 | 1SL5094A00 | 25X100 | 1X4 | 1970 | 18 | 14 | 11 | 9 | 7 | 6 | 5 | 4 | 3 | 3 | 2 | | | |
| 05195 | 05095 | 1SL5195A00 | 1SL5095A00 | 40X100 | 1 1/2X4 | 3410 | 31 | 25 | 20 | 15 | 13 | 11 | 9 | 8 | 6 | 5 | 4 | | | |
| 05196 | 05096 | 1SL5196A00 | 1SL5096A00 | 60X100 | 2 1/4X4 | 5300 | 49 | 39 | 31 | 24 | 20 | 17 | 14 | 13 | 10 | 8 | 6 | | | |
| 05197 | 05097 | 1SL5197A00 | 1SL5097A00 | 80X100 | 3X4 | 7190 | 67 | 53 | 42 | 33 | 28 | 23 | 20 | 17 | 14 | 11 | 9 | | | |
| 05198 | 05098 | 1SL5198A00 | 1SL5098A00 | 100X100 | 4X4 | 9110 | 85 | 67 | 53 | 42 | 35 | 29 | 25 | 22 | 18 | 14 | 11 | | | |
| 05199 | 05099 | 1SL5199A00 | 1SL5099A00 | 150X100 | 6X4 | 13,740 | 128 | 101 | 80 | 64 | 54 | 45 | 38 | 33 | 27 | 22 | 18 | | | |

Wiring duct

Technical data

Wire capacity, 800 - 1000 AWG

800 - 1000 AWG

| Gray 4/6 slot | Gray 8/12 slot | ABB wiring duct code | | Nominal duct size (mm) | Nominal duct size (inches) | Usable areas (mm ²) | Maximum number of wires according to AGW and cable section (mm ²) | |
|------------------|-------------------|----------------------|--------------------|------------------------------|----------------------------------|---------------------------------------|---|-------------|
| | | White 4/6 slot | White 8/12 slot | | | | 800 405 | 1000 508 |
| 05119 | 05019 | 1SL5119A00 | 1SL5019A00 | 15x17 | 1/2x5/8 | 110 | 0 | 0 |
| 05133 | 05033 | 1SL5133A00 | 1SL5033A00 | 25x30 | 1x1 1/4 | 490 | 0 | 0 |
| 05135 | 05035 | 1SL5135A00 | 1SL5035A00 | 40X30 | 1 1/2X1 1/4 | 890 | 1 | 0 |
| 05137 | 05037 | 1SL5137A00 | 1SL5037A00 | 60x30 | 2 1/4x1 1/4 | 1430 | 1 | 1 |
| 05143 | 05043 | 1SL5143A00 | 1SL5043A00 | 25X40 | 1X1 1/2 | 710 | 0 | 0 |
| 05145 | 05045 | 1SL5145A00 | 1SL5045A00 | 40x40 | 1 1/2x1 1/2 | 1260 | 1 | 1 |
| 05147 | 05047 | 1SL5147A00 | 1SL5047A00 | 60x40 | 2 1/4x1 1/2 | 2000 | 2 | 1 |
| 05149 | 05049 | 1SL5149A00 | 1SL5049A00 | 80X40 | 3X1 1/2 | 2710 | 3 | 2 |
| 05151 | 05051 | 1SL5151A00 | 1SL5051A00 | 100X40 | 4X1 1/2 | 3460 | 4 | 3 |
| 05153 | 05053 | 1SL5153A00 | 1SL5053A00 | 120X40 | 4 3/4X1 1/2 | 4200 | 5 | 4 |
| 05163 | 05063 | 1SL5163A00 | 1SL5063A00 | 25X60 | 1 X 2 1/4 | 1120 | 1 | 1 |
| 05165 | 05065 | 1SL5165A00 | 1SL5065A00 | 40X60 | 1 1/2X2 1/4 | 1970 | 2 | 1 |
| 05167 | 05067 | 1SL5167A00 | 1SL5067A00 | 60X60 | 2 1/4X2 1/4 | 3060 | 3 | 3 |
| 05169 | 05069 | 1SL5169A00 | 1SL5069A00 | 80X60 | 3X2 1/4 | 4190 | 5 | 4 |
| 05171 | 05071 | 1SL5171A00 | 1SL5071A00 | 100X60 | 4X2 1/4 | 5320 | 6 | 5 |
| 05173 | 05073 | 1SL5173A00 | 1SL5073A00 | 120X60 | 4 3/4X2 1/4 | 6330 | 7 | 6 |
| 05183 | 05083 | 1SL5183A00 | 1SL5083A00 | 25X80 | 1X3 | 1540 | 1 | 1 |
| 05185 | 05085 | 1SL5185A00 | 1SL5085A00 | 40X80 | 1 1/2X3 | 2670 | 3 | 2 |
| 05187 | 05087 | 1SL5187A00 | 1SL5087A00 | 60X80 | 2 1/4X3 | 4140 | 5 | 4 |
| 05189 | 05089 | 1SL5189A00 | 1SL5089A00 | 80X80 | 3X3 | 5650 | 6 | 5 |
| 05191 | 05091 | 1SL5191A00 | 1SL5091A00 | 100X80 | 4X3 | 7170 | 8 | 7 |
| 05193 | 05093 | 1SL5193A00 | 1SL5093A00 | 120X80 | 4 3/4X3 | 8570 | 10 | 8 |
| 05194 | 05094 | 1SL5194A00 | 1SL5094A00 | 25X100 | 1X4 | 1970 | 2 | 1 |
| 05195 | 05095 | 1SL5195A00 | 1SL5095A00 | 40X100 | 1 1/2X4 | 3410 | 4 | 3 |
| 05196 | 05096 | 1SL5196A00 | 1SL5096A00 | 60X100 | 2 1/4X4 | 5300 | 6 | 5 |
| 05197 | 05097 | 1SL5197A00 | 1SL5097A00 | 80X100 | 3X4 | 7190 | 8 | 7 |
| 05198 | 05098 | 1SL5198A00 | 1SL5098A00 | 100X100 | 4X4 | 9110 | 11 | 8 |
| 05199 | 05099 | 1SL5199A00 | 1SL5099A00 | 150X100 | 6X4 | 13,740 | 16 | 13 |

Wiring duct Technical data

- Gray color — RAL 7030
- White color — RAL 9016
- Plastic insulating, shock-proof, self-extinguishing material in compliance with UL 94 VO Standard and resistant to abnormal heat and fire up to 960° (glow wire test) in compliance with IEC 695-2-1 Standard. UL File # E125800
- Minimum storage/transport temperature -5°C
- Minimum installation and usage temperature -15°C
- Maximum usage temperature +60°C.
- Resistance to acids, oils and greases
- No burr, rounded-off inner edges
- New rib profile makes it easy to open and close the cover and guarantees that it clips on more safely
- Designed to snap onto the Fix-O-rapid special accessory, suitable to be fastened both to DIN rail and base plate
- The ribs are cut using a special pressing process (rounding of the edges) producing wiring ducts completely free of burr and rough edges
- The dimensions and resilience of the ribs ensure repeated splaying during cabling
- Controlled splaying of sides to ensure a perfect seal of the cover in the vertical sections and at high temperatures
- Double trimming line, one at the base of the ribs so that they can be removed by bending them outwards, and one at the base of the lateral sides so that the edge can be cut when two wiring ducts are branched
- Cable holder moldings half-way up the straight section of the ribs in 80 and 100 mm high wiring ducts
- Cover can be opened without having to use a special tool
- Can be mounted on horizontal or vertical surfaces even when the cover is on the bottom
- Standard 2 meter length
- Industrial application

Wiring duct

Technical data

Resistance to chemical agents

| Chemical | Concentration | Temp. °C | Resistance | Chemical | Concentration | Temp. °C | Resistance |
|--------------------------|-----------------|----------|------------|-------------------------|---------------|----------|------------|
| Acetic acid, hydrous | 10% | 50 | ① | Formic acid | 100% | 20 | ① |
| Acetic acid' | 60% | 50 | ① | Freon 12 | — | 20 | ① |
| Acetone | Traces | 20 | ② | Gasoline | — | 50 | ① |
| Acetone | 100% | 20 | ② | Glycerine, hydrous | — | 50 | ① |
| Acqua regia | — | 20 | ① | Hydrochloric acid | saturated | 50 | ① |
| Ammonia concentrate | 88% | 50 | ① | Hydrogen | — | 50 | ① |
| Ammonia, dry gas | 100% | 50 | ① | Linseed oil | — | 50 | ① |
| Ammonia, liquid | 100% | 20 | ③ | Lubricating oils | — | 50 | ① |
| Aniline, pure | 100% | 20 | ② | Mineral oil | — | 50 | ① |
| Arsenic acid, hydrous | concentrated | 20 | ① | Molasses | — | 20 | ④ |
| Barium hydroxide, hydr. | — | 50 | ① | Oils and fats | commercial | 50 | ① |
| Beer | commercial | 20 | ① | Oil of turpentine | commercial | 20 | ① |
| Benzene | — | 20 | ② | Ozone | — | 20 | ① |
| Benzoic acid | — | 20 | ③ | Paraffin wax | — | 50 | ① |
| Borax, hydrous | thinned | 50 | ① | Photographic developer | commercial | 50 | ① |
| Boric acid, hydrous | thinned | 50 | ① | Photographic emulsions | — | 50 | ① |
| Brandy | commercial | 20 | ① | Potassium permanganate | 6% | 20 | ① |
| Bromide liquid | — | 20 | ② | Propane, liquid | — | 20 | ① |
| Butane gaseous | — | 20 | ① | Salicylic acid | — | 50 | ① |
| Butadiene | 50% | 50 | ① | Sea water | — | 50 | ① |
| Butanol | — | 20 | ① | Soda, hydrous | saturated | 50 | ① |
| Butyric acid, hydrous | 20% | 20 | ① | Sodium chloride | thinned | 50 | ① |
| Calcium chloride | — | 50 | ① | Spirits, all types | — | 20 | ① |
| Camphor oil | — | 20 | ① | Sulphur | — | 50 | ① |
| Carbon tetrachloride | — | 20 | ③ | Sulphuric acid, hydrous | 40% | 50 | ① |
| Chlorine gaseous, dry | 100% | 20 | ① | Tannic acid | — | 50 | ① |
| Chlorine gaseous, moist | 20% | 20 | ③ | Tetrahydrofuran | — | 20 | ② |
| Chlorine water | saturated | 20 | ③ | Toluene | — | 20 | ② |
| Chromic acid, hydrous | — | 50 | ① | Urea, hydrous | — | 50 | ① |
| Citric acid, hydrous | — | 50 | ① | Urine | — | 50 | ① |
| Copper sulphate, hydrous | thinned | 50 | ① | Vinegar | commercial | 50 | ① |
| Diesel oil | — | 20 | ① | Water | — | 50 | ① |
| Ethyl-alcohol | 100% (in water) | 20 | ① | Wines, red & white | commercial | 20 | ① |
| Formaldehyde, hydrous | 40% | 50 | ① | Zinc sulphate, hydrous | thinned | 50 | ① |

① Resistant
 ② Not sufficiently resistant
 ③ Resistant in certain conditions
 ④ Resistance to this product has been determined from the resistance to chemical products of similar composition

Wiring duct Approximate dimensions

00.00 — Inches
00.00 — [Millimeters]

.31 – .47" [8-12 mm] slot
.87" [17 mm] height

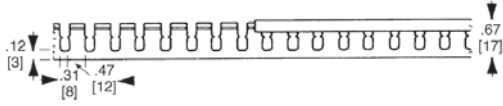

1.18" [30 mm] height

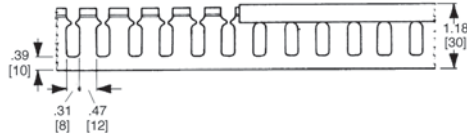

1.57" [40 mm] height

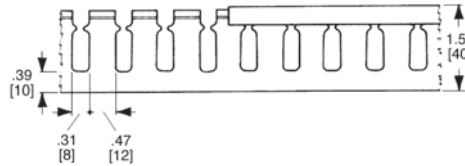

2.36" [60 mm] height

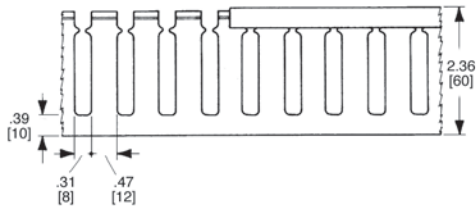

3.15", 3.94" [80 mm, 100 mm] height

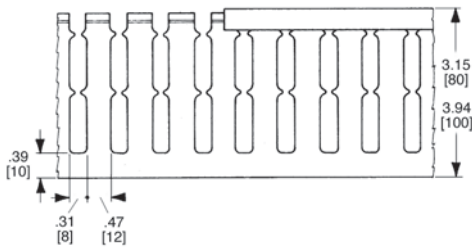

.16 – .24" [4 – 6 mm] slot
1.47" [40 mm] height

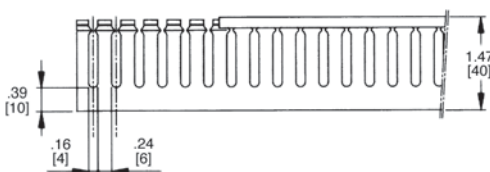

2.36" [60 mm] height

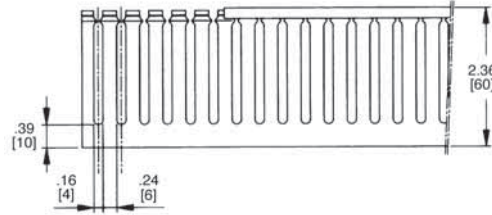

3.15", 3.94" [80 mm, 100 mm] height

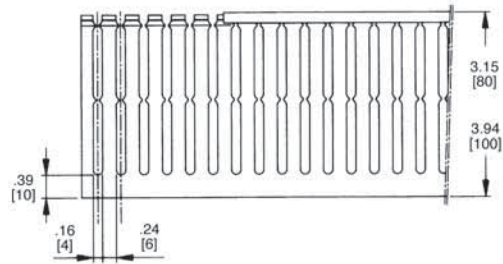

.16 – .24" [4 – 6 mm] & .31 – .47" [8 – 12 mm] spacing
.59" [15 mm] width

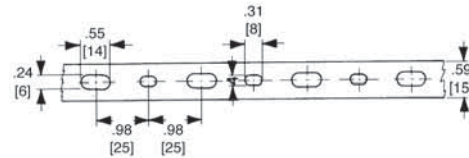

.98", 1.57", 2.36" [25, 40, 60 mm] width

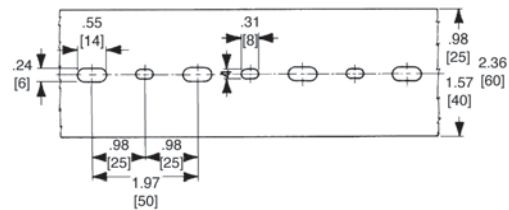

1.57", 1.97", 2.95" [80, 100, 150 mm] width

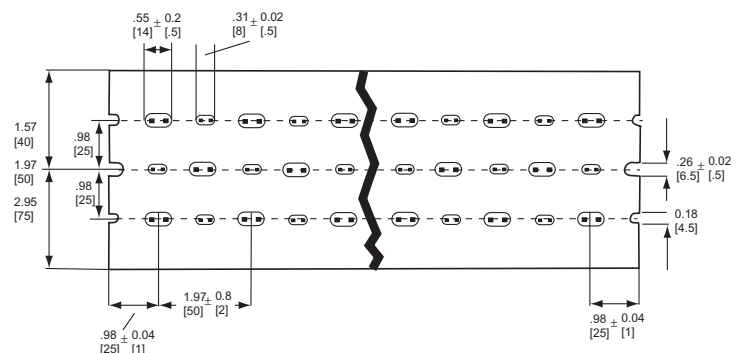

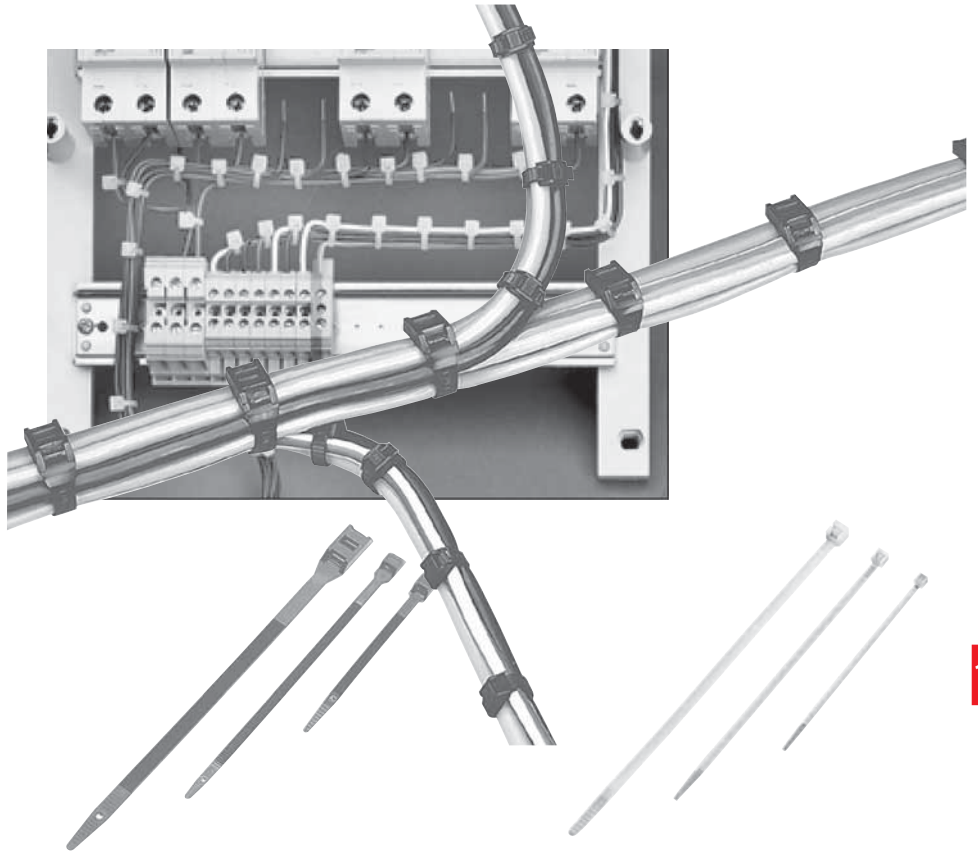

Features

- Easy to install and remove.
- Provides protection to the wire bundle.
- Available in white and black

Applications

- Fast and economical grouping of wire bundles.
- Joining groups of wires and/or tubing.
- Flexible connections between door and panel

Cable ties



Sample cable tie installations



White 6/6 polyamide cable ties



Black 6/6 polyamide cable ties



Black 12 polyamide cable ties

Cable ties

| Item L x W ② | Minimum tensile strength (lbs.) | Pieces per ① package | Catalog number ① | List price per package |
|---------------------------------|------------------------------------|-------------------------|---------------------|---------------------------|
| White (6/6 polyamide) | | | | |
| 3.94" (100 mm) x .10" (2.5 mm) | 24 | 100 | 18010 | \$ 6.50 |
| 5.31" (135 mm) x .10" (2.5 mm) | 24 | | 18011 | 7.00 |
| 6.30" (160 mm) x .10" (2.5 mm) | 24 | | 18013 | 8.00 |
| 5.51" (140 mm) x .14" (3.5 mm) | 44 | | 18012 | 8.00 |
| 7.87" (200 mm) x .14" (3.5 mm) | 44 | | 18014 | 9.00 |
| 11.02" (280 mm) x .14" (3.5 mm) | 44 | | 18017 | 12.00 |
| 7.09" (180 mm) x .17" (4.5 mm) | 61 | | 18015 | 10.25 |
| 11.02" (280 mm) x .17" (4.5 mm) | 61 | | 18018 | 19.00 |
| 14.17" (360 mm) x .17" (4.5 mm) | 61 | | 18020 | 23.00 |
| 7.87" (200 mm) x .30" (7.5 mm) | 143 | | 18024 | 22.00 |
| 11.02" (280 mm) x .30" (7.5 mm) | 143 | | 18026 | 28.00 |
| 14.17" (360 mm) x .30" (7.5 mm) | 143 | | 18028 | 34.00 |
| 16.92" (430 mm) x .35" (9 mm) | 176 | | 18034 | 46.00 |
| 21.65" (550 mm) x .35" (9 mm) | 176 | | 18036 | 55.00 |
| 30.71" (780 mm) x .35" (9 mm) | 176 | | 18038 | 75.00 |
| White (6/6 bulk) | | | | |
| 3.94" (100 mm) x .10" (2.5 mm) | 24 | 1000 | 18060 | 55.00 |
| 5.31" (135 mm) x .10" (2.5 mm) | 24 | | 18061 | 60.00 |
| 6.30" (160 mm) x .10" (2.5 mm) | 24 | | 18063 | 70.00 |
| 5.51" (140 mm) x .14" (3.5 mm) | 44 | | 18062 | 70.00 |
| 7.87" (200 mm) x .14" (3.5 mm) | 44 | | 18064 | 80.00 |
| Black (6/6 polyamide) | | | | |
| 3.94" (100 mm) x .10" (2.5 mm) | 24 | 100 | 18110 | 6.75 |
| 5.31" (135 mm) x .10" (2.5 mm) | 24 | | 18111 | 7.25 |
| 6.30" (160 mm) x .10" (2.5 mm) | 24 | | 18113 | 8.50 |
| 5.51" (140 mm) x .14" (3.5 mm) | 44 | | 18112 | 8.25 |
| 7.87" (200 mm) x .14" (3.5 mm) | 44 | | 18114 | 9.50 |
| 11.02" (280 mm) x .14" (3.5 mm) | 44 | | 18117 | 13.00 |
| 7.09" (180 mm) x .17" (4.5 mm) | 61 | | 18115 | 10.75 |
| 11.02" (280 mm) x .17" (4.5 mm) | 61 | | 18118 | 20.50 |
| 14.17" (360 mm) x .17" (4.5 mm) | 61 | | 18120 | 25.00 |
| 7.87" (200 mm) x .30" (7.5 mm) | 143 | | 18124 | 24.00 |
| 11.02" (280 mm) x .30" (7.5 mm) | 143 | | 18126 | 31.00 |
| 14.17" (360 mm) x .30" (7.5 mm) | 143 | | 18128 | 37.00 |
| 16.92" (430 mm) x .35" (9 mm) | 176 | | 18134 | 48.00 |
| 21.65" (550 mm) x .35" (9 mm) | 176 | | 18136 | 57.00 |
| 30.71" (780 mm) x .35" (9 mm) | 176 | | 18138 | 77.00 |
| Black (6/6 bulk) | | | | |
| 3.94" (100 mm) x .10" (2.5 mm) | 24 | 1000 | 18160 | 57.00 |
| 5.31" (135 mm) x .10" (2.5 mm) | 24 | | 18161 | 63.00 |
| 6.30" (160 mm) x .10" (2.5 mm) | 24 | | 18163 | 77.00 |
| 5.51" (140 mm) x .14" (3.5 mm) | 44 | | 18162 | 77.00 |
| 7.87" (200 mm) x .14" (3.5 mm) | 44 | | 18164 | 85.00 |
| Black (12 polyamide) | | | | |
| 4.53" (115 mm) x .24" (6 mm) | 55 | 100 | 18210 | 21.00 |
| 6.89" (175 mm) x .24" (6 mm) | 55 | | 18212 | 24.00 |
| 4.53" (115 mm) x .35" (9 mm) | 88 | | 18218 | 32.00 |
| 7.09" (180 mm) x .35" (9 mm) | 110 | | 18220 | 36.00 |
| 10.43" (265 mm) x .35" (9 mm) | 110 | | 18222 | 42.00 |
| 14.17" (360 mm) x .35" (9 mm) | 110 | | 18224 | 55.00 |

① Sold in package quantity only.

② 25.4mm = 1 inch

Cable ties Accessories

Cable tie accessories



18250



18252



18270



18280



18282



18290

| Item | Pieces per package ^① | Catalog number ^① | List price per package |
|---|---------------------------------|-----------------------------|------------------------|
| Self-adhesive base for cable ties (clear) | 50 | 18250 | \$ 18.00 |
| Self-adhesive base for cable ties (black) | 50 | 18251 | 18.00 |
| Screw mounted base for cable ties (clear) | 100 | 18252 | 14.00 |
| Screw mounted base for cable ties (black) | 100 | 18253 | 14.00 |
| Cable tie cutter | 1 | 18270 | 150.00 |
| Screw mounted base for cable ties | 25 | 18280 | 13.00 |
| Push-in base for cable ties | 25 | 18282 | 20.00 |
| Outer cable tie cutter | 1 | 18290 | 80.00 |

① Sold in package quantity only.

Cable ties

Technical data & approximate dimensions

General features

- Manufactured in 6/6 nylon: Colorless for general uses
- Better stored at mild temperatures, away from heat and excessively dry conditions
- Black cable ties are UV resistant; excellent for outdoor applications

Thermal properties

- Suitable for use at temperatures from -40° to +110°C
- Softening point VICAT B/50-DIN 53460 over 200°C

Electrical characteristics











- Dielectric endurance 50,000 V/mm

Chemical characteristics

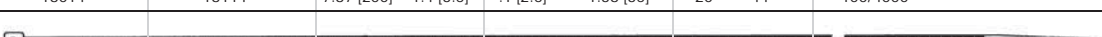
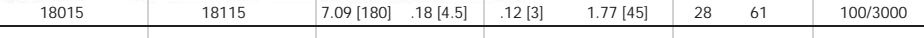
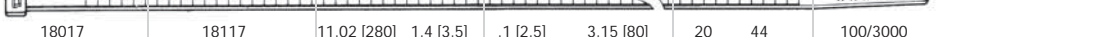
- Good resistance to bases, oil, grease, hydrocarbons, acetone, chlorales
- Limited concentrated acid resistance
- Dissolved by phenol and formic acid

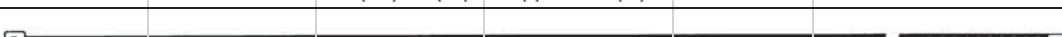
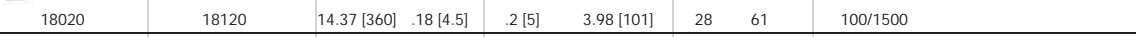
Mechanical characteristics

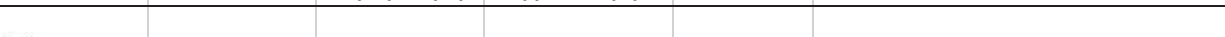
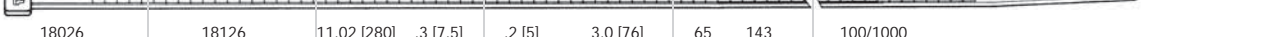
- Bending point DIN 53452 110 M Pa
- Load point DIN 53457 2800 M Pa
- Resilience DIN 53453 6-8 KJ/m²
- Yield point DIN 53456 80 M Pa
- Stretch point DIN 53455 35%
- Hardness DIN 53456 125 N/mm²

| White polyamide Catalog number | Black polyamide Catalog number | Size | | Tightening diameter | | Minimum tightness | | Pcs Unit/pack |
|--|--------------------------------------|--------------|--------------|---------------------|--------------------|----------------------|--------|------------------|
| | | L in [mm] | D in [mm] | Minimum in [mm] | Maximum in [mm] | (N) | (lbs.) | |
|  18010 | 18110 | 3.94 [100] | .1 [2.5] | .08 [2] | .94 [24] | 11 | 24 | 100/8000 |
|  18013 | 18113 | 6.29 [160] | .1 [2.5] | .08 [2] | 1.65 [42] | 11 | 24 | 100/5000 |
|  18012 | 18112 | 5.51 [140] | .14 [3.5] | .1 [2.5] | 1.42 [36] | 20 | 44 | 100/5000 |
|  18011 | 18111 | 5.31 [135] | .1 [2.5] | .08 [2] | 1.38 [35] | 11 | 24 | 100/6000 |
|  18014 | 18114 | 7.87 [200] | 1.4 [3.5] | .1 [2.5] | 1.38 [35] | 20 | 44 | 100/4000 |
|  18015 | 18115 | 7.09 [180] | .18 [4.5] | .12 [3] | 1.77 [45] | 28 | 61 | 100/3000 |
|  18017 | 18117 | 11.02 [280] | 1.4 [3.5] | .1 [2.5] | 3.15 [80] | 20 | 44 | 100/3000 |
|  18018 | 18118 | 11.02 [280] | .18 [4.5] | .2 [5] | 3.0 [76] | 28 | 61 | 100/2500 |
|  18020 | 18120 | 14.37 [360] | .18 [4.5] | .2 [5] | 3.98 [101] | 28 | 61 | 100/1500 |
|  18024 | 18124 | 7.87 [200] | .3 [7.5] | .2 [5] | 2 [51] | 65 | 143 | 100/2000 |
|  18026 | 18126 | 11.02 [280] | .3 [7.5] | .2 [5] | 3.0 [76] | 65 | 143 | 100/1000 |
|  18034 | 18134 | 16.93 [430] | .35 [9.0] | .2 [5.0] | 4.33 [110] | 80 | 176 | 100/2000 |
|  18036 | 18136 | 21.65 [550] | .35 [9.0] | .2 [5.0] | 5.51 [140] | 80 | 176 | 100/2000 |
|  18038 | 18138 | 30.71 [780] | .35 [9.0] | .2 [5.0] | 7.48 [190] | 80 | 176 | 100/800 |
|  18028 | 18128 | 14.17 [360] | .3 [7.5] | .2 [5.0] | 4.02 [102] | 65 | 143 | 100/2000 |

Cable ties

Technical data & approximate dimensions

General features

- Manufactured in 12 nylon
- Moisture absorption less than 1%
- Black cable ties are UV resistant; excellent for outdoor applications

Thermal properties

- Suitable for use at temperatures from -30° to +80°C
- Softening point VICAT VST/B/50-DIN 53460 over 160°C

Electrical characteristics

- Dielectric endurance 28,000 V/mm

Chemical characteristics

- Good resistance to bases, oil, grease, hydrocarbons, acetone, chlorales
- Limited resistance to nitric and chromic acid

Mechanical characteristics

- Bending point DIN 53452 20 M Pa
- Load point DIN 53457 420 M Pa
- Breaking load point DIN 53455 61 M Pa
- Resilience 20°C DIN 53453 KJ/m not broken
- Yield point DIN 53456 24 M Pa
- Stretch point DIN 53455 37%
- Hardness G2 Shore D

| Black polyamide Catalog number | Size | | Tightening diameter | | Minimum tightness | | Pcs Unit/pack |
|--------------------------------------|--------------|--------------|---------------------|--------------------|----------------------|--------|------------------|
| | L In [mm] | D in [mm] | Minimum in [mm] | Maximum in [mm] | (N) | (lbs.) | |
| 18210 | 4.53 [115] | .24 [6] | .2 [5] | .79 [20] | 25 | 55 | 100/3000 |
| 18212 | 6.89 [175] | .24 [6] | .39 [10] | 1.57 [40] | 25 | 55 | 100/2000 |
| 18218 | 4.53 [115] | .35 [9] | .2 [5] | .79 [20] | 40 | 88 | 100/2000 |
| 18220 | 7.09 [180] | .35 [9] | .39 [10] | 1.77 [45] | 50 | 110 | 100/2000 |
| 18222 | 10.43 [265] | .35 [9] | .59 [15] | 2.75 [70] | 50 | 110 | 100/1000 |
| 18224 | 14.17 [360] | .35 [9] | .98 [25] | 3.94 [100] | 50 | 110 | 100/800 |

Cable ties Approximate dimensions

00.00 → Inches
00.00 → [Millimeters]

18250 & 18251
Self-adhesive base for cable ties

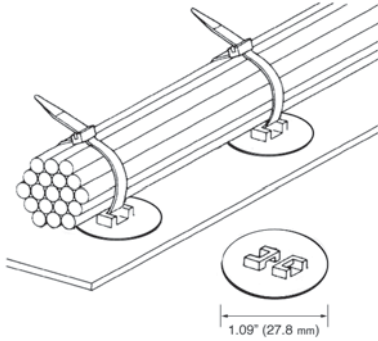

18280
Screw-mounted base for cable ties

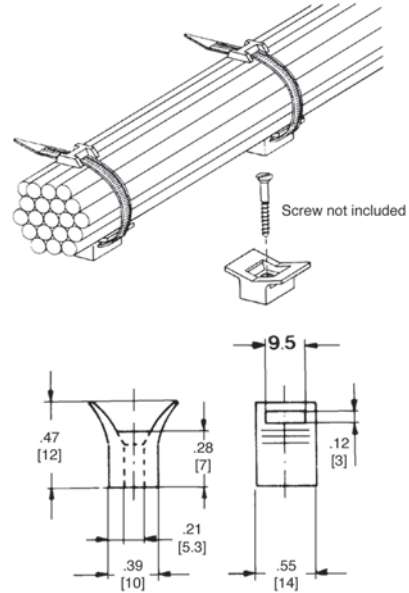

18252 & 18253
Screw-mounted base for cable ties

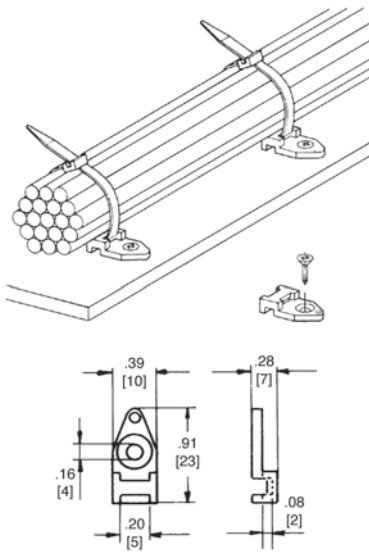

18282
Push-in base for cable ties

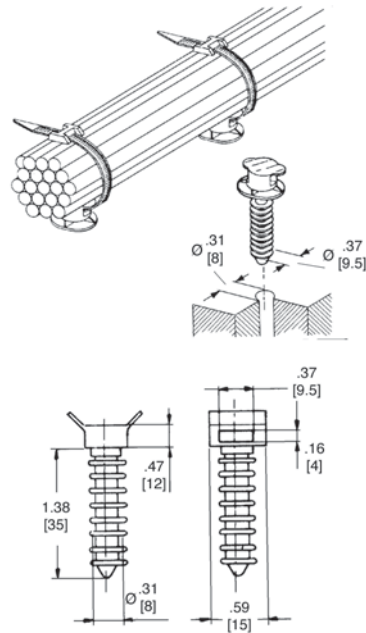

18270
Cable tie cutter

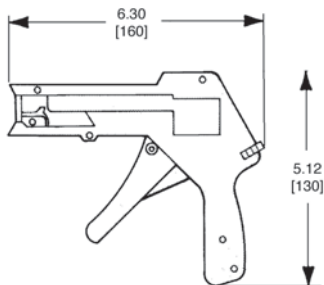

18270
Cable tie cutter

